

LORRIC[®]

paranoid about performance

Nozzle And Flowmeter Product Catalogue



LORRIC

LORRIC is a Taiwanese manufacturer of industrial nozzles and flow meters established in 1991, and since then has dealt in independent research and development, design, production, marketing, and sales. LORRIC's products are 100% made in Taiwan. The philosophy we believe in, as mentioned below, leads us to design and manufacture supreme products while improving and growing with our clients.

Consistently self-challenging, we settle on only producing the highest quality nozzles through our uncompromising attitude.

At LORRIC, we pride ourselves in creating industry-used high-grade nozzles through our meticulous techniques and exclusive knowledge. Through our craftsmen's vast experience and diligence in understanding our customers' requests, our products' high quality ensures that even under the harshest of environments, they will perform as accurate as ever.

LORRIC wishes to stand together with customers and partners who embrace similar values, and together fashion a network of cooperation and mutual-support.

LORRIC takes to heart its clients' demands for performance, and cautiously tackles every challenge presented. Taking inspiration from whales, who deep down in the wide blue ocean sing their songs to call their peers in an extraordinary frequency of 52 hertz, LORRIC too is looking for clients who embrace similar values, and like-minded global partners. Let us together become a community, and share with the world our values and uncompromising spirit.

LORRIC aims to lead the Taiwanese industry, and stand firmly on the world stage of industrial production.

Contents

Flat Fan Nozzles	H	6	Full Cone Nozzles	QT	56	
	VH	10		KDMF	57	
	V	14		KPMF M	58	
	CH	18		KPMF P	60	
	PF	22		KJ	62	
	F	23		KG	63	
	QFH	24		Hollow Cone Nozzles	ST	66
	QFYH	28			MWT	67
	QSH	32			QSWP	68
	DVEH	36		Other Nozzles	SPP	70
	D clamp	37			ED	71
	KAD	38			ED MINI	72
	HB	39			BB	73
Full Cone Nozzles	KP M	42	TB		73	
	KP P	44	Nozzle Accessories	QFSA	76	
	KH	46		QFWG	76	
	QSF	47	Why LORRIC	Flat fan nozzle's estimated spray coverage	78	
	QFF	48		Immediately understanding how to read "Flow Rate"	79	
	QFMF	50		Comparison of particle size of 3 common kinds of nozzles	79	
	QFYF	52		3 facts you must know about "spray angle"	80	
	QFYMF	54		Impact vs pressure distribution	81	

Flat Fan Nozzles



H	6
VH	10
V	14
CH	18
PF	22
F	23
QFH	24
QFYH	28
QSH	32
DVEH	36
D clamp	37
KAD	38
HB	39

H Single piece flat fan nozzle



【 Top view of nozzle spray pattern 】



【 Flow distribution 】

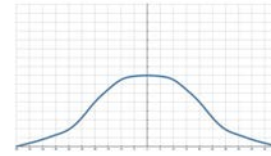

- PP material:
- Recommended working pressure: 3.0 kgf/cm²
 - Flowrate tolerance: ± 10% @ 3.0 ± 0.1 kgf/cm²
 - Angle tolerance: ± 10° @ 3.0 ± 0.1 kgf/cm²
 - Jet angle tolerance: 3°
- Other materials:
- Recommended working pressure: 3.0 kgf/cm²
 - Flowrate tolerance: ± 5% @ 3.0 ± 0.1 kgf/cm²
 - Angle tolerance: ± 5° @ 3.0 ± 0.1 kgf/cm²
 - Jet angle tolerance: 3°

Features

- The spraying type is fan type, and the spray shape is single line and two sides are tapered (tapered edge), which presents a bell curve shape flow field distribution with weaker ends compared to the middle.
- Single-piece design, if there is frequent maintenance or replacement requirements, it is recommended to use quick install with multiple pieces nozzles.
- Fan nozzle angle can be 0°~110°, 0° spray angle spray type

is straight column, spray Fog shape is a single point, providing the best impact in all nozzle types.

- When the fan nozzle is used in high pressure environment, choose HSS material (hardened stainless steel Steel), can operate under 200Kgf/cm² pressure

Applications

- Cleaning: Vehicles, Containers, Filters, Dust, Gravel, Metals, Metal Parts, Machinery, Steel Plates, Various Containers, High Pressure Cleaning, Wet Processing Display Pane, machine tool cleaning, etc.
- Cooling: gas, tank, machinery, metal, roof etc.
- Dispersion: Humidifying, Chemicals (etching solution, lubricants, insect repellent, etc.), water screens (fire, dust, deodorization etc.).

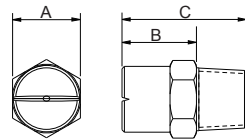

Appearance dimensions may vary depending on model, material. Please ask for details.

Material	Serie	Unit (mm)			Thread Type	Weight (g)				
		A	B	C		S303	S316	BRASS	HSS	PP
Metal	1/8H	12	11	19	1/8M	10.8	10.8	12.5	10.8	-
	1/4H	14	15	26	1/4M	11.5	11.5	14	11.5	-
	3/8H	18	15	30	3/8M	39	44.5	48	44.5	-
Plastic	1/8H	11.8	10.3	19	1/8M	-	-	-	-	1.5
	1/4H	13.7	13.7	25	1/4M	-	-	-	-	2.0
	3/8H	18	18	30	3/8M	-	-	-	-	8.0

Material

- Metal: Stainless 303, Stainless 316, BRASS, HSS
- Plastic: PP

How to place an order for LORRIC nozzles?

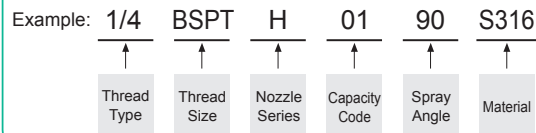

※ Standard Pressure: Column in red.
 ※ This product for spray angle 0°, 15°, 25°, 40°, 50°, 100° and 110° is able to be made to order.

Spray Angle	Capacity Code	Thread Size			Capacity at Pressure										Average particle size (um)	Min. Free Passage (mm)	Filter mesh
		1/8	1/4	3/8	0.5 kgf/cm ²	1.0 kgf/cm ²	2.0 kgf/cm ²	3.0 kgf/cm ²	4.0 kgf/cm ²	6.0 kgf/cm ²	8.0 kgf/cm ²	10.0 kgf/cm ²	15.0 kgf/cm ²				
0°	1	V	V		0.16	0.23	0.32	0.39	0.45	0.55	0.64	0.71	0.87	-	-	-	
	2	V	V		0.32	0.45	0.64	0.78	0.90	1.11	1.28	1.43	1.75	-	-	-	
	2.5	V	V		0.40	0.56	0.80	0.98	1.13	1.38	1.60	1.78	2.19	-	-	-	
	3	V	V		0.48	0.68	0.96	1.17	1.35	1.66	1.92	2.14	2.62	-	-	-	
	4	V	V		0.64	0.90	1.28	1.56	1.81	2.21	2.55	2.86	3.50	-	-	-	
	5	V	V		0.80	1.13	1.60	1.96	2.26	2.76	3.19	3.57	4.37	-	-	-	
	6	V	V		0.96	1.35	1.92	2.35	2.71	3.32	3.83	4.28	5.25	-	-	-	
	7	V	V		1.12	1.58	2.23	2.74	3.16	3.87	4.47	5.00	6.12	-	-	-	
	7.5	V	V		1.20	1.69	2.39	2.93	3.39	4.15	4.79	5.35	6.56	-	-	-	
	8	V	V		1.28	1.81	2.55	3.13	3.61	4.42	5.11	5.71	6.99	-	-	-	
	9	V	V		1.44	2.03	2.87	3.52	4.06	4.98	5.75	6.42	7.87	-	-	-	
	10	V	V		1.60	2.26	3.19	3.91	4.51	5.53	6.39	7.14	8.74	-	-	-	
	12.5	V	V		2.00	2.82	3.99	4.89	5.64	6.91	7.98	8.92	10.93	-	-	-	
	15	V	V		2.39	3.39	4.79	5.87	6.77	8.29	9.58	10.71	13.11	-	-	-	
	20	V	V		3.19	4.51	6.39	7.82	9.03	11.06	12.77	14.28	17.49	-	-	-	
	25		V		3.99	5.64	7.98	9.78	11.29	13.82	15.96	17.85	21.86	-	-	-	
	30		V	V	4.79	6.77	9.58	11.73	13.54	16.59	19.16	21.42	26.23	-	-	-	
35		V	V	5.59	7.90	11.17	13.69	15.80	19.35	22.35	24.99	30.60	-	-	-		
40		V	V	6.39	9.03	12.77	15.64	18.06	22.12	25.54	28.55	34.97	-	-	-		
50		V	V	7.98	11.29	15.96	19.55	22.57	27.65	31.93	35.69	43.72	-	-	-		
60			V	9.58	13.54	19.16	23.46	27.09	33.18	38.31	42.83	52.46	-	-	-		
80			V	12.77	18.06	25.54	31.38	36.12	44.24	51.08	57.11	69.94	-	-	-		
100			V	15.96	22.57	31.93	39.10	45.15	55.30	63.85	71.39	87.43	-	-	-		

※ For MPa / bar / psi units, please refer to LORRIC.com.

Spray Angle	Capacity Code	Thread Size			Capacity at Pressure									Average particle size (µm)	Min. Free Passage (mm)	Filter mesh
		1/8	1/4	3/8	0.5 kgf/cm ²	1.0 kgf/cm ²	2.0 kgf/cm ²	3.0 kgf/cm ²	4.0 kgf/cm ²	6.0 kgf/cm ²	8.0 kgf/cm ²	10.0 kgf/cm ²	15.0 kgf/cm ²			
15°	1	V	V		0.16	0.23	0.32	0.39	0.45	0.55	0.64	0.71	0.87	-	-	-
	2	V	V		0.32	0.45	0.64	0.78	0.90	1.11	1.28	1.43	1.75	-	-	-
	2.5	V	V		0.40	0.56	0.80	0.98	1.13	1.38	1.60	1.78	2.19	-	-	-
	3	V	V		0.48	0.68	0.96	1.17	1.35	1.66	1.92	2.14	2.62	-	-	-
	4	V	V		0.64	0.90	1.28	1.56	1.81	2.21	2.55	2.86	3.50	-	-	-
	5	V	V		0.80	1.13	1.60	1.96	2.26	2.76	3.19	3.57	4.37	-	-	-
	6	V	V		0.96	1.35	1.92	2.35	2.71	3.32	3.83	4.28	5.25	-	-	-
	7	V	V		1.12	1.58	2.23	2.74	3.16	3.87	4.47	5.00	6.12	-	-	-
	7.5	V	V		1.20	1.69	2.39	2.93	3.39	4.15	4.79	5.35	6.56	-	-	-
	8	V	V		1.28	1.81	2.55	3.13	3.61	4.42	5.11	5.71	6.99	-	-	-
	9	V	V		1.44	2.03	2.87	3.52	4.06	4.98	5.75	6.42	7.87	-	-	-
	10	V	V		1.60	2.26	3.19	3.91	4.51	5.53	6.39	7.14	8.74	-	-	-
	12.5	V	V		2.00	2.82	3.99	4.89	5.64	6.91	7.98	8.92	10.93	-	-	-
	15	V	V		2.39	3.39	4.79	5.87	6.77	8.29	9.58	10.71	13.11	-	-	-
	20	V	V		3.19	4.51	6.39	7.82	9.03	11.06	12.77	14.28	17.49	-	-	-
	25		V		3.99	5.64	7.98	9.78	11.29	13.82	15.96	17.85	21.86	-	-	-
	30		V	V	4.79	6.77	9.58	11.73	13.54	16.59	19.16	21.42	26.23	-	-	-
	35		V	V	5.59	7.90	11.17	13.69	15.80	19.35	22.35	24.99	30.60	-	-	-
	40		V	V	6.39	9.03	12.77	15.64	18.06	22.12	25.54	28.55	34.97	-	-	-
	50		V	V	7.98	11.29	15.96	19.55	22.57	27.65	31.93	35.69	43.72	-	-	-
60			V	9.58	13.54	19.16	23.46	27.09	33.18	38.31	42.83	52.46	-	-	-	
80			V	12.77	18.06	25.54	31.38	36.12	44.24	51.08	57.11	69.94	-	-	-	
100			V	15.96	22.57	31.93	39.10	45.15	55.30	63.85	71.39	87.43	-	-	-	
25°	1	V	V		0.16	0.23	0.32	0.39	0.45	0.55	0.64	0.71	0.87	-	-	-
	2	V	V		0.32	0.45	0.64	0.78	0.90	1.11	1.28	1.43	1.75	-	-	-
	2.5	V	V		0.40	0.56	0.80	0.98	1.13	1.38	1.60	1.78	2.19	-	-	-
	3	V	V		0.48	0.68	0.96	1.17	1.35	1.66	1.92	2.14	2.62	-	-	-
	4	V	V		0.64	0.90	1.28	1.56	1.81	2.21	2.55	2.86	3.50	-	-	-
	5	V	V		0.80	1.13	1.60	1.96	2.26	2.76	3.19	3.57	4.37	-	-	-
	6	V	V		0.96	1.35	1.92	2.35	2.71	3.32	3.83	4.28	5.25	-	-	-
	7	V	V		1.12	1.58	2.23	2.74	3.16	3.87	4.47	5.00	6.12	-	-	-
	7.5	V	V		1.20	1.69	2.39	2.93	3.39	4.15	4.79	5.35	6.56	-	-	-
	8	V	V		1.28	1.81	2.55	3.13	3.61	4.42	5.11	5.71	6.99	-	-	-
	9	V	V		1.44	2.03	2.87	3.52	4.06	4.98	5.75	6.42	7.87	-	-	-
	10	V	V		1.60	2.26	3.19	3.91	4.51	5.53	6.39	7.14	8.74	-	-	-
	12.5	V	V		2.00	2.82	3.99	4.89	5.64	6.91	7.98	8.92	10.93	-	-	-
	15	V	V		2.39	3.39	4.79	5.87	6.77	8.29	9.58	10.71	13.11	-	-	-
	20	V	V		3.19	4.51	6.39	7.82	9.03	11.06	12.77	14.28	17.49	-	-	-
	25		V		3.99	5.64	7.98	9.78	11.29	13.82	15.96	17.85	21.86	-	-	-
	30		V	V	4.79	6.77	9.58	11.73	13.54	16.59	19.16	21.42	26.23	-	-	-
	35		V	V	5.59	7.90	11.17	13.69	15.80	19.35	22.35	24.99	30.60	-	-	-
	40		V	V	6.39	9.03	12.77	15.64	18.06	22.12	25.54	28.55	34.97	-	-	-
	50		V	V	7.98	11.29	15.96	19.55	22.57	27.65	31.93	35.69	43.72	-	-	-
60			V	9.58	13.54	19.16	23.46	27.09	33.18	38.31	42.83	52.46	-	-	-	
80			V	12.77	18.06	25.54	31.38	36.12	44.24	51.08	57.11	69.94	-	-	-	
100			V	15.96	22.57	31.93	39.10	45.15	55.30	63.85	71.39	87.43	-	-	-	
40°	1	V	V		0.16	0.23	0.32	0.39	0.45	0.55	0.64	0.71	0.87	-	-	-
	2	V	V		0.32	0.45	0.64	0.78	0.90	1.11	1.28	1.43	1.75	-	-	-
	2.5	V	V		0.40	0.56	0.80	0.98	1.13	1.38	1.60	1.78	2.19	-	-	-
	3	V	V		0.48	0.68	0.96	1.17	1.35	1.66	1.92	2.14	2.62	-	-	-
	4	V	V		0.64	0.90	1.28	1.56	1.81	2.21	2.55	2.86	3.50	-	-	-
	5	V	V		0.80	1.13	1.60	1.96	2.26	2.76	3.19	3.57	4.37	-	-	-
	6	V	V		0.96	1.35	1.92	2.35	2.71	3.32	3.83	4.28	5.25	-	-	-
	7	V	V		1.12	1.58	2.23	2.74	3.16	3.87	4.47	5.00	6.12	-	-	-
	7.5	V	V		1.20	1.69	2.39	2.93	3.39	4.15	4.79	5.35	6.56	-	-	-
	8	V	V		1.28	1.81	2.55	3.13	3.61	4.42	5.11	5.71	6.99	-	-	-
	9	V	V		1.44	2.03	2.87	3.52	4.06	4.98	5.75	6.42	7.87	-	-	-
	10	V	V		1.60	2.26	3.19	3.91	4.51	5.53	6.39	7.14	8.74	-	-	-
	12.5	V	V		2.00	2.82	3.99	4.89	5.64	6.91	7.98	8.92	10.93	-	-	-
	15	V	V		2.39	3.39	4.79	5.87	6.77	8.29	9.58	10.71	13.11	-	-	-
	20	V	V		3.19	4.51	6.39	7.82	9.03	11.06	12.77	14.28	17.49	-	-	-
	25		V		3.99	5.64	7.98	9.78	11.29	13.82	15.96	17.85	21.86	-	-	-
	30		V	V	4.79	6.77	9.58	11.73	13.54	16.59	19.16	21.42	26.23	-	-	-
	35		V	V	5.59	7.90	11.17	13.69	15.80	19.35	22.35	24.99	30.60	-	-	-
	40		V	V	6.39	9.03	12.77	15.64	18.06	22.12	25.54	28.55	34.97	-	-	-
	50		V	V	7.98	11.29	15.96	19.55	22.57	27.65	31.93	35.69	43.72	-	-	-
60			V	9.58	13.54	19.16	23.46	27.09	33.18	38.31	42.83	52.46	-	-	-	
80			V	12.77	18.06	25.54	31.38	36.12	44.24	51.08	57.11	69.94	-	-	-	
100			V	15.96	22.57	31.93	39.10	45.15	55.30	63.85	71.39	87.43	-	-	-	

※ For MPa / bar / psi units, please refer to LORRIC.com.

Spray Angle	Capacity Code	Thread Size			Capacity at Pressure									Average particle size (um)	Min. Free Passage (mm)	Filter mesh
		1/8	1/4	3/8	0.5 kgf/cm ²	1.0 kgf/cm ²	2.0 kgf/cm ²	3.0 kgf/cm ²	4.0 kgf/cm ²	6.0 kgf/cm ²	8.0 kgf/cm ²	10.0 kgf/cm ²	15.0 kgf/cm ²			
50°	1	V	V		0.16	0.23	0.32	0.39	0.45	0.55	0.64	0.71	0.87	-	-	-
	2	V	V		0.32	0.45	0.64	0.78	0.90	1.11	1.28	1.43	1.75	-	-	-
	2.5	V	V		0.40	0.56	0.80	0.98	1.13	1.38	1.60	1.78	2.19	-	-	-
	3	V	V		0.48	0.68	0.96	1.17	1.35	1.66	1.92	2.14	2.62	-	-	-
	4	V	V		0.64	0.90	1.28	1.56	1.81	2.21	2.55	2.86	3.50	-	-	-
	5	V	V		0.80	1.13	1.60	1.96	2.26	2.76	3.19	3.57	4.37	-	-	-
	6	V	V		0.96	1.35	1.92	2.35	2.71	3.32	3.83	4.28	5.25	-	-	-
	7	V	V		1.12	1.58	2.23	2.74	3.16	3.87	4.47	5.00	6.12	-	-	-
	7.5	V	V		1.20	1.69	2.39	2.93	3.39	4.15	4.79	5.35	6.56	-	-	-
	8	V	V		1.28	1.81	2.55	3.13	3.61	4.42	5.11	5.71	6.99	-	-	-
	9	V	V		1.44	2.03	2.87	3.52	4.06	4.98	5.75	6.42	7.87	-	-	-
	10	V	V		1.60	2.26	3.19	3.91	4.51	5.53	6.39	7.14	8.74	-	-	-
	12.5	V	V		2.00	2.82	3.99	4.89	5.64	6.91	7.98	8.92	10.93	-	-	-
	15	V	V		2.39	3.39	4.79	5.87	6.77	8.29	9.58	10.71	13.11	-	-	-
	20	V	V		3.19	4.51	6.39	7.82	9.03	11.06	12.77	14.28	17.49	-	-	-
	25	V	V		3.99	5.64	7.98	9.78	11.29	13.82	15.96	17.85	21.86	-	-	-
	30		V	V	4.79	6.77	9.58	11.73	13.54	16.59	19.16	21.42	26.23	-	-	-
	35		V	V	5.59	7.90	11.17	13.69	15.80	19.35	22.35	24.99	30.60	-	-	-
	40		V	V	6.39	9.03	12.77	15.64	18.06	22.12	25.54	28.55	34.97	-	-	-
	50		V	V	7.98	11.29	15.96	19.55	22.57	27.65	31.93	35.69	43.72	-	-	-
60			V	9.58	13.54	19.16	23.46	27.09	33.18	38.31	42.83	52.46	-	-	-	
80			V	12.77	18.06	25.54	31.38	36.12	44.24	51.08	57.11	69.94	-	-	-	
100			V	15.96	22.57	31.93	39.10	45.15	55.30	63.85	71.39	87.43	-	-	-	
65°	1	V	V		0.16	0.23	0.32	0.39	0.45	0.55	0.64	0.71	0.87	140	0.2	200
	2	V	V		0.32	0.45	0.64	0.78	0.90	1.11	1.28	1.43	1.75	-	0.4	150
	2.5	V	V		0.40	0.56	0.80	0.98	1.13	1.38	1.60	1.78	2.19	-	0.6	100
	3	V	V		0.48	0.68	0.96	1.17	1.35	1.66	1.92	2.14	2.62	-	0.7	100
	4	V	V		0.64	0.90	1.28	1.56	1.81	2.21	2.55	2.86	3.50	-	0.8	50
	5	V	V		0.80	1.13	1.60	1.96	2.26	2.76	3.19	3.57	4.37	-	0.9	50
	6	V	V		0.96	1.35	1.92	2.35	2.71	3.32	3.83	4.28	5.25	230	0.9	50
	7	V	V		1.12	1.58	2.23	2.74	3.16	3.87	4.47	5.00	6.12	-	1.0	-
	7.5	V	V		1.20	1.69	2.39	2.93	3.39	4.15	4.79	5.35	6.56	-	1.0	-
	8	V	V		1.28	1.81	2.55	3.13	3.61	4.42	5.11	5.71	6.99	-	1.1	-
	9	V	V		1.44	2.03	2.87	3.52	4.06	4.98	5.75	6.42	7.87	-	1.1	-
	10	V	V		1.60	2.26	3.19	3.91	4.51	5.53	6.39	7.14	8.74	-	1.2	-
	12.5	V	V		2.00	2.82	3.99	4.89	5.64	6.91	7.98	8.92	10.93	-	1.3	-
	15	V	V		2.39	3.39	4.79	5.87	6.77	8.29	9.58	10.71	13.11	-	1.4	-
	20	V	V		3.19	4.51	6.39	7.82	9.03	11.06	12.77	14.28	17.49	370	1.6	-
	25		V		3.99	5.64	7.98	9.78	11.29	13.82	15.96	17.85	21.86	-	2.0	-
	30		V	V	4.79	6.77	9.58	11.73	13.54	16.59	19.16	21.42	26.23	-	2.3	-
	35		V	V	5.59	7.90	11.17	13.69	15.80	19.35	22.35	24.99	30.60	-	2.4	-
	40		V	V	6.39	9.03	12.77	15.64	18.06	22.12	25.54	28.55	34.97	-	2.5	-
	50		V	V	7.98	11.29	15.96	19.55	22.57	27.65	31.93	35.69	43.72	-	2.8	-
60			V	9.58	13.54	19.16	23.46	27.09	33.18	38.31	42.83	52.46	-	3.1	-	
80			V	12.77	18.06	25.54	31.38	36.12	44.24	51.08	57.11	69.94	-	3.3	-	
100			V	15.96	22.57	31.93	39.10	45.15	55.30	63.85	71.39	87.43	630	3.9	-	
80°	1	V	V		0.16	0.23	0.32	0.39	0.45	0.55	0.64	0.71	0.87	135	0.2	200
	2	V	V		0.32	0.45	0.64	0.78	0.90	1.11	1.28	1.43	1.75	-	0.3	150
	2.5	V	V		0.40	0.56	0.80	0.98	1.13	1.38	1.60	1.78	2.19	-	0.4	150
	3	V	V		0.48	0.68	0.96	1.17	1.35	1.66	1.92	2.14	2.62	-	0.4	150
	4	V	V		0.64	0.90	1.28	1.56	1.81	2.21	2.55	2.86	3.50	-	0.6	100
	5	V	V		0.80	1.13	1.60	1.96	2.26	2.76	3.19	3.57	4.37	220	0.7	50
	6	V	V		0.96	1.35	1.92	2.35	2.71	3.32	3.83	4.28	5.25	-	0.7	50
	7	V	V		1.12	1.58	2.23	2.74	3.16	3.87	4.47	5.00	6.12	-	0.9	50
	7.5	V	V		1.20	1.69	2.39	2.93	3.39	4.15	4.79	5.35	6.56	-	0.9	50
	8	V	V		1.28	1.81	2.55	3.13	3.61	4.42	5.11	5.71	6.99	-	1.0	-
	9	V	V		1.44	2.03	2.87	3.52	4.06	4.98	5.75	6.42	7.87	-	1.0	-
	10	V	V		1.60	2.26	3.19	3.91	4.51	5.53	6.39	7.14	8.74	-	1.1	-
	12.5	V	V		2.00	2.82	3.99	4.89	5.64	6.91	7.98	8.92	10.93	-	1.3	-
	15	V	V		2.39	3.39	4.79	5.87	6.77	8.29	9.58	10.71	13.11	-	1.4	-
	20	V	V		3.19	4.51	6.39	7.82	9.03	11.06	12.77	14.28	17.49	340	1.6	-
	25		V		3.99	5.64	7.98	9.78	11.29	13.82	15.96	17.85	21.86	-	1.9	-
	30		V	V	4.79	6.77	9.58	11.73	13.54	16.59	19.16	21.42	26.23	-	2.1	-
	35		V	V	5.59	7.90	11.17	13.69	15.80	19.35	22.35	24.99	30.60	-	2.3	-
	40		V	V	6.39	9.03	12.77	15.64	18.06	22.12	25.54	28.55	34.97	-	2.4	-
	50		V	V	7.98	11.29	15.96	19.55	22.57	27.65	31.93	35.69	43.72	-	2.8	-
60			V	9.58	13.54	19.16	23.46	27.09	33.18	38.31	42.83	52.46	-	2.5	-	
80			V	12.77	18.06	25.54	31.38	36.12	44.24	51.08	57.11	69.94	-	3.1	-	
100			V	15.96	22.57	31.93	39.10	45.15	55.30	63.85	71.39	87.43	600	3.7	-	

※ For MPa / bar / psi units, please refer to LORRIC.com.

Spray Angle	Capacity Code	Thread Size			Capacity at Pressure										Average particle size (µm)	Min. Free Passage (mm)	Filter mesh
		1/8	1/4	3/8	0.5 kgf/cm ²	1.0 kgf/cm ²	2.0 kgf/cm ²	3.0 kgf/cm ²	4.0 kgf/cm ²	6.0 kgf/cm ²	8.0 kgf/cm ²	10.0 kgf/cm ²	15.0 kgf/cm ²				
90°	1	V	V		0.16	0.23	0.32	0.39	0.45	0.55	0.64	0.71	0.87	130	0.2	200	
	2	V	V		0.32	0.45	0.64	0.78	0.90	1.11	1.28	1.43	1.75	-	0.3	150	
	2.5	V	V		0.40	0.56	0.80	0.98	1.13	1.38	1.60	1.78	2.19	-	0.4	150	
	3	V	V		0.48	0.68	0.96	1.17	1.35	1.66	1.92	2.14	2.62	-	0.4	150	
	4	V	V		0.64	0.90	1.28	1.56	1.81	2.21	2.55	2.86	3.50	-	0.5	100	
	5	V	V		0.80	1.13	1.60	1.96	2.26	2.76	3.19	3.57	4.37	-	0.5	100	
	6	V	V		0.96	1.35	1.92	2.35	2.71	3.32	3.83	4.28	5.25	210	0.5	100	
	7	V	V		1.12	1.58	2.23	2.74	3.16	3.87	4.47	5.00	6.12	-	0.6	100	
	7.5	V	V		1.20	1.69	2.39	2.93	3.39	4.15	4.79	5.35	6.56	-	0.8	50	
	8	V	V		1.28	1.81	2.55	3.13	3.61	4.42	5.11	5.71	6.99	330	0.8	50	
	9	V	V		1.44	2.03	2.87	3.52	4.06	4.98	5.75	6.42	7.87	-	0.8	50	
	10	V	V		1.60	2.26	3.19	3.91	4.51	5.53	6.39	7.14	8.74	-	1.0	-	
	12.5	V	V		2.00	2.82	3.99	4.89	5.64	6.91	7.98	8.92	10.93	-	1.1	-	
	15	V	V		2.39	3.39	4.79	5.87	6.77	8.29	9.58	10.71	13.11	-	1.2	-	
	20	V	V		3.19	4.51	6.39	7.82	9.03	11.06	12.77	14.28	17.49	-	1.4	-	
	25		V		3.99	5.64	7.98	9.78	11.29	13.82	15.96	17.85	21.86	-	1.6	-	
	30		V	V	4.79	6.77	9.58	11.73	13.54	16.59	19.16	21.42	26.23	-	1.8	-	
	35		V	V	5.59	7.90	11.17	13.69	15.80	19.35	22.35	24.99	30.60	-	2.0	-	
	40		V	V	6.39	9.03	12.77	15.64	18.06	22.12	25.54	28.55	34.97	-	2.1	-	
	50		V	V	7.98	11.29	15.96	19.55	22.57	27.65	31.93	35.69	43.72	-	2.3	-	
60			V	9.58	13.54	19.16	23.46	27.09	33.18	38.31	42.83	52.46	-	2.5	-		
80			V	12.77	18.06	25.54	31.38	36.12	44.24	51.08	57.11	69.94	-	2.7	-		
100			V	15.96	22.57	31.93	39.10	45.15	55.30	63.85	71.39	87.43	570	3.3	-		
100°	1	V	V		0.16	0.23	0.32	0.39	0.45	0.55	0.64	0.71	0.87	-	-	-	
	2	V	V		0.32	0.45	0.64	0.78	0.90	1.11	1.28	1.43	1.75	-	-	-	
	2.5	V	V		0.40	0.56	0.80	0.98	1.13	1.38	1.60	1.78	2.19	-	-	-	
	3	V	V		0.48	0.68	0.96	1.17	1.35	1.66	1.92	2.14	2.62	-	-	-	
	4	V	V		0.64	0.90	1.28	1.56	1.81	2.21	2.55	2.86	3.50	-	-	-	
	5	V	V		0.80	1.13	1.60	1.96	2.26	2.76	3.19	3.57	4.37	-	-	-	
	6	V	V		0.96	1.35	1.92	2.35	2.71	3.32	3.83	4.28	5.25	-	-	-	
	7	V	V		1.12	1.58	2.23	2.74	3.16	3.87	4.47	5.00	6.12	-	-	-	
	7.5	V	V		1.20	1.69	2.39	2.93	3.39	4.15	4.79	5.35	6.56	-	-	-	
	8	V	V		1.28	1.81	2.55	3.13	3.61	4.42	5.11	5.71	6.99	-	-	-	
	9	V	V		1.44	2.03	2.87	3.52	4.06	4.98	5.75	6.42	7.87	-	-	-	
	10	V	V		1.60	2.26	3.19	3.91	4.51	5.53	6.39	7.14	8.74	-	-	-	
	12.5	V	V		2.00	2.82	3.99	4.89	5.64	6.91	7.98	8.92	10.93	-	-	-	
	15	V	V		2.39	3.39	4.79	5.87	6.77	8.29	9.58	10.71	13.11	-	-	-	
	20	V	V		3.19	4.51	6.39	7.82	9.03	11.06	12.77	14.28	17.49	-	-	-	
	25		V		3.99	5.64	7.98	9.78	11.29	13.82	15.96	17.85	21.86	-	-	-	
	30		V	V	4.79	6.77	9.58	11.73	13.54	16.59	19.16	21.42	26.23	-	-	-	
	35		V	V	5.59	7.90	11.17	13.69	15.80	19.35	22.35	24.99	30.60	-	-	-	
	40		V	V	6.39	9.03	12.77	15.64	18.06	22.12	25.54	28.55	34.97	-	-	-	
	50		V	V	7.98	11.29	15.96	19.55	22.57	27.65	31.93	35.69	43.72	-	-	-	
60			V	9.58	13.54	19.16	23.46	27.09	33.18	38.31	42.83	52.46	-	-	-		
80			V	12.77	18.06	25.54	31.38	36.12	44.24	51.08	57.11	69.94	-	-	-		
100			V	15.96	22.57	31.93	39.10	45.15	55.30	63.85	71.39	87.43	-	-	-		
110°	1	V	V		0.16	0.23	0.32	0.39	0.45	0.55	0.64	0.71	0.87	-	-	-	
	2	V	V		0.32	0.45	0.64	0.78	0.90	1.11	1.28	1.43	1.75	-	-	-	
	2.5	V	V		0.40	0.56	0.80	0.98	1.13	1.38	1.60	1.78	2.19	-	-	-	
	3	V	V		0.48	0.68	0.96	1.17	1.35	1.66	1.92	2.14	2.62	-	-	-	
	4	V	V		0.64	0.90	1.28	1.56	1.81	2.21	2.55	2.86	3.50	-	-	-	
	5	V	V		0.80	1.13	1.60	1.96	2.26	2.76	3.19	3.57	4.37	-	-	-	
	6	V	V		0.96	1.35	1.92	2.35	2.71	3.32	3.83	4.28	5.25	-	-	-	
	7	V	V		1.12	1.58	2.23	2.74	3.16	3.87	4.47	5.00	6.12	-	-	-	
	7.5	V	V		1.20	1.69	2.39	2.93	3.39	4.15	4.79	5.35	6.56	-	-	-	
	8	V	V		1.28	1.81	2.55	3.13	3.61	4.42	5.11	5.71	6.99	-	-	-	
	9	V	V		1.44	2.03	2.87	3.52	4.06	4.98	5.75	6.42	7.87	-	-	-	
	10	V	V		1.60	2.26	3.19	3.91	4.51	5.53	6.39	7.14	8.74	-	-	-	
	12.5	V	V		2.00	2.82	3.99	4.89	5.64	6.91	7.98	8.92	10.93	-	-	-	
	15	V	V		2.39	3.39	4.79	5.87	6.77	8.29	9.58	10.71	13.11	-	-	-	
	20	V	V		3.19	4.51	6.39	7.82	9.03	11.06	12.77	14.28	17.49	-	-	-	
	25		V		3.99	5.64	7.98	9.78	11.29	13.82	15.96	17.85	21.86	-	-	-	
	30		V	V	4.79	6.77	9.58	11.73	13.54	16.59	19.16	21.42	26.23	-	-	-	
	35		V	V	5.59	7.90	11.17	13.69	15.80	19.35	22.35	24.99	30.60	-	-	-	
	40		V	V	6.39	9.03	12.77	15.64	18.06	22.12	25.54	28.55	34.97	-	-	-	
	50		V	V	7.98	11.29	15.96	19.55	22.57	27.65	31.93	35.69	43.72	-	-	-	
60			V	9.58	13.54	19.16	23.46	27.09	33.18	38.31	42.83	52.46	-	-	-		
80			V	12.77	18.06	25.54	31.38	36.12	44.24	51.08	57.11	69.94	-	-	-		
100			V	15.96	22.57	31.93	39.10	45.15	55.30	63.85	71.39	87.43	-	-	-		

※ For MPa / bar / psi units, please refer to LORRIC.com.

VH Single piece high chemical resistance plastic flat fan nozzle

Flat Fan Nozzles



【 Top view of nozzle spray pattern 】



【 Flow distribution 】

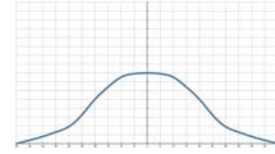

- Recommended working pressure: 3.0 kgf/cm²
- Flowrate tolerance: ± 5% @ 3.0 ± 0.1 kgf/cm²
- Angle tolerance: ± 5° @ 3.0 ± 0.1 kgf/cm²
- Jet angle tolerance: 3°

Features

- The spraying type is fan type, and the spray shape is single-line and the two sides are tapered (tapered Edge), which presents a bell curve shape flow field distribution with weaker ends compared to the middle.
- One-piece design.
- PVDF is resistant to temperature and corrosive chemical solutions.

Applications

- Cleaning: Vehicles, containers, filters, dust, gravel, metals, metal parts, mechanical, steel plates, various containers, high pressure cleaning, wet processing, display panel, cleaning process for TFT-LCD manufacturing, machinery washing, etc.
- Cooling: Gas, tank, machinery, metal, roof, etc.
- Dispersion: Humidifying, chemicals (eg. etching solution, lubricants, insect repellent, etc.), firefighting, dedust, deodorization, etc.

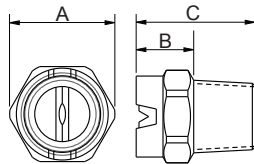

Appearance dimensions may vary depending on model, material. Please ask for details.

Material	Serie	Unit (mm)			Thread Type	Weight (g)
		A	B	C		
PVDF	1/8VH	12	11	19	1/8M	2.2
	1/4VH	15	11	21	1/4M	3.7
	3/8VH	17	12	19	3/8M	14

Material

- Plastic: PVDF

How to place an order for LORRIC nozzles?

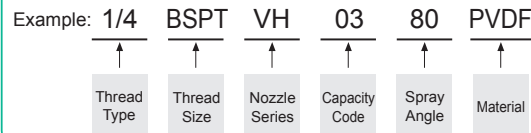

※ Standard Pressure: Column in red.
 ※ This product for spray angle 0°, 15° 25°, 40°, 50°, 100° and 110° is able to be made to order.

Spray Angle	Capacity Code	Thread Size			Capacity at Pressure											Average particle size (um)	Min. Free Passage (mm)	Filter mesh
		1/8	1/4	3/8	0.5 kgf/cm ²	1.0 kgf/cm ²	2.0 kgf/cm ²	3.0 kgf/cm ²	4.0 kgf/cm ²	6.0 kgf/cm ²	8.0 kgf/cm ²	10.0 kgf/cm ²	15.0 kgf/cm ²					
0°	1	V	V		0.16	0.23	0.32	0.39	0.45	0.55	0.64	0.71	0.87	-	-	-		
	2	V	V		0.32	0.45	0.64	0.78	0.90	1.11	1.28	1.43	1.75	-	-	-		
	2.5	V	V		0.40	0.56	0.80	0.98	1.13	1.38	1.60	1.78	2.19	-	-	-		
	3	V	V		0.48	0.68	0.96	1.17	1.35	1.66	1.92	2.14	2.62	-	-	-		
	4	V	V		0.64	0.90	1.28	1.56	1.81	2.21	2.55	2.86	3.50	-	-	-		
	5	V	V		0.80	1.13	1.60	1.96	2.26	2.76	3.19	3.57	4.37	-	-	-		
	6	V	V		0.96	1.35	1.92	2.35	2.71	3.32	3.83	4.28	5.25	-	-	-		
	7	V	V		1.12	1.58	2.23	2.74	3.16	3.87	4.47	5.00	6.12	-	-	-		
	7.5	V	V		1.20	1.69	2.39	2.93	3.39	4.15	4.79	5.35	6.56	-	-	-		
	8	V	V		1.28	1.81	2.55	3.13	3.61	4.42	5.11	5.71	6.99	-	-	-		
	9	V	V		1.44	2.03	2.87	3.52	4.06	4.98	5.75	6.42	7.87	-	-	-		
	10	V	V		1.60	2.26	3.19	3.91	4.51	5.53	6.39	7.14	8.74	-	-	-		
	12.5	V	V		2.00	2.82	3.99	4.89	5.64	6.91	7.98	8.92	10.93	-	-	-		
	15	V	V		2.39	3.39	4.79	5.87	6.77	8.29	9.58	10.71	13.11	-	-	-		
	20	V	V		3.19	4.51	6.39	7.82	9.03	11.06	12.77	14.28	17.49	-	-	-		
	25		V		3.99	5.64	7.98	9.78	11.29	13.82	15.96	17.85	21.86	-	-	-		
	30		V	V	4.79	6.77	9.58	11.73	13.54	16.59	19.16	21.42	26.23	-	-	-		
	35		V	V	5.59	7.90	11.17	13.69	15.80	19.35	22.35	24.99	30.60	-	-	-		
40		V	V	6.39	9.03	12.77	15.64	18.06	22.12	25.54	28.55	34.97	-	-	-			
50		V	V	7.98	11.29	15.96	19.55	22.57	27.65	31.93	35.69	43.72	-	-	-			
60		V	V	9.58	13.54	19.16	23.46	27.09	33.18	38.31	42.83	52.46	-	-	-			
80		V	V	12.77	18.06	25.54	31.38	36.12	44.24	51.08	57.11	69.94	-	-	-			
100		V	V	15.96	22.57	31.93	39.10	45.15	55.30	63.85	71.39	87.43	-	-	-			

※ For MPa / bar / psi units, please refer to LORRIC.com.

Spray Angle	Capacity Code	Thread Size			Capacity at Pressure										Average particle size (um)	Min. Free Passage (mm)	Filter mesh
		1/8	1/4	3/8	0.5 kgf/cm ²	1.0 kgf/cm ²	2.0 kgf/cm ²	3.0 kgf/cm ²	4.0 kgf/cm ²	6.0 kgf/cm ²	8.0 kgf/cm ²	10.0 kgf/cm ²	15.0 kgf/cm ²				
15°	1	V	V		0.16	0.23	0.32	0.39	0.45	0.55	0.64	0.71	0.87	-	-	-	
	2	V	V		0.32	0.45	0.64	0.78	0.90	1.11	1.28	1.43	1.75	-	-	-	
	2.5	V	V		0.40	0.56	0.80	0.98	1.13	1.38	1.60	1.78	2.19	-	-	-	
	3	V	V		0.48	0.68	0.96	1.17	1.35	1.66	1.92	2.14	2.62	-	-	-	
	4	V	V		0.64	0.90	1.28	1.56	1.81	2.21	2.55	2.86	3.50	-	-	-	
	5	V	V		0.80	1.13	1.60	1.96	2.26	2.76	3.19	3.57	4.37	-	-	-	
	6	V	V		0.96	1.35	1.92	2.35	2.71	3.32	3.83	4.28	5.25	-	-	-	
	7	V	V		1.12	1.58	2.23	2.74	3.16	3.87	4.47	5.00	6.12	-	-	-	
	7.5	V	V		1.20	1.69	2.39	2.93	3.39	4.15	4.79	5.35	6.56	-	-	-	
	8	V	V		1.28	1.81	2.55	3.13	3.61	4.42	5.11	5.71	6.99	-	-	-	
	9	V	V		1.44	2.03	2.87	3.52	4.06	4.98	5.75	6.42	7.87	-	-	-	
	10	V	V		1.60	2.26	3.19	3.91	4.51	5.53	6.39	7.14	8.74	-	-	-	
	12.5	V	V		2.00	2.82	3.99	4.89	5.64	6.91	7.98	8.92	10.93	-	-	-	
	15	V	V		2.39	3.39	4.79	5.87	6.77	8.29	9.58	10.71	13.11	-	-	-	
	20	V	V		3.19	4.51	6.39	7.82	9.03	11.06	12.77	14.28	17.49	-	-	-	
	25		V		3.99	5.64	7.98	9.78	11.29	13.82	15.96	17.85	21.86	-	-	-	
	30		V	V	4.79	6.77	9.58	11.73	13.54	16.59	19.16	21.42	26.23	-	-	-	
	35		V	V	5.59	7.90	11.17	13.69	15.80	19.35	22.35	24.99	30.60	-	-	-	
	40		V	V	6.39	9.03	12.77	15.64	18.06	22.12	25.54	28.55	34.97	-	-	-	
	50		V	V	7.98	11.29	15.96	19.55	22.57	27.65	31.93	35.69	43.72	-	-	-	
60			V	9.58	13.54	19.16	23.46	27.09	33.18	38.31	42.83	52.46	-	-	-		
80			V	12.77	18.06	25.54	31.38	36.12	44.24	51.08	57.11	69.94	-	-	-		
100			V	15.96	22.57	31.93	39.10	45.15	55.30	63.85	71.39	87.43	-	-	-		
25°	1	V	V		0.16	0.23	0.32	0.39	0.45	0.55	0.64	0.71	0.87	-	-	-	
	2	V	V		0.32	0.45	0.64	0.78	0.90	1.11	1.28	1.43	1.75	-	-	-	
	2.5	V	V		0.40	0.56	0.80	0.98	1.13	1.38	1.60	1.78	2.19	-	-	-	
	3	V	V		0.48	0.68	0.96	1.17	1.35	1.66	1.92	2.14	2.62	-	-	-	
	4	V	V		0.64	0.90	1.28	1.56	1.81	2.21	2.55	2.86	3.50	-	-	-	
	5	V	V		0.80	1.13	1.60	1.96	2.26	2.76	3.19	3.57	4.37	-	-	-	
	6	V	V		0.96	1.35	1.92	2.35	2.71	3.32	3.83	4.28	5.25	-	-	-	
	7	V	V		1.12	1.58	2.23	2.74	3.16	3.87	4.47	5.00	6.12	-	-	-	
	7.5	V	V		1.20	1.69	2.39	2.93	3.39	4.15	4.79	5.35	6.56	-	-	-	
	8	V	V		1.28	1.81	2.55	3.13	3.61	4.42	5.11	5.71	6.99	-	-	-	
	9	V	V		1.44	2.03	2.87	3.52	4.06	4.98	5.75	6.42	7.87	-	-	-	
	10	V	V		1.60	2.26	3.19	3.91	4.51	5.53	6.39	7.14	8.74	-	-	-	
	12.5	V	V		2.00	2.82	3.99	4.89	5.64	6.91	7.98	8.92	10.93	-	-	-	
	15	V	V		2.39	3.39	4.79	5.87	6.77	8.29	9.58	10.71	13.11	-	-	-	
	20	V	V		3.19	4.51	6.39	7.82	9.03	11.06	12.77	14.28	17.49	-	-	-	
	25		V		3.99	5.64	7.98	9.78	11.29	13.82	15.96	17.85	21.86	-	-	-	
	30		V	V	4.79	6.77	9.58	11.73	13.54	16.59	19.16	21.42	26.23	-	-	-	
	35		V	V	5.59	7.90	11.17	13.69	15.80	19.35	22.35	24.99	30.60	-	-	-	
	40		V	V	6.39	9.03	12.77	15.64	18.06	22.12	25.54	28.55	34.97	-	-	-	
	50		V	V	7.98	11.29	15.96	19.55	22.57	27.65	31.93	35.69	43.72	-	-	-	
60			V	9.58	13.54	19.16	23.46	27.09	33.18	38.31	42.83	52.46	-	-	-		
80			V	12.77	18.06	25.54	31.38	36.12	44.24	51.08	57.11	69.94	-	-	-		
100			V	15.96	22.57	31.93	39.10	45.15	55.30	63.85	71.39	87.43	-	-	-		
40°	1	V	V		0.16	0.23	0.32	0.39	0.45	0.55	0.64	0.71	0.87	-	-	-	
	2	V	V		0.32	0.45	0.64	0.78	0.90	1.11	1.28	1.43	1.75	-	-	-	
	2.5	V	V		0.40	0.56	0.80	0.98	1.13	1.38	1.60	1.78	2.19	-	-	-	
	3	V	V		0.48	0.68	0.96	1.17	1.35	1.66	1.92	2.14	2.62	-	-	-	
	4	V	V		0.64	0.90	1.28	1.56	1.81	2.21	2.55	2.86	3.50	-	-	-	
	5	V	V		0.80	1.13	1.60	1.96	2.26	2.76	3.19	3.57	4.37	-	-	-	
	6	V	V		0.96	1.35	1.92	2.35	2.71	3.32	3.83	4.28	5.25	-	-	-	
	7	V	V		1.12	1.58	2.23	2.74	3.16	3.87	4.47	5.00	6.12	-	-	-	
	7.5	V	V		1.20	1.69	2.39	2.93	3.39	4.15	4.79	5.35	6.56	-	-	-	
	8	V	V		1.28	1.81	2.55	3.13	3.61	4.42	5.11	5.71	6.99	-	-	-	
	9	V	V		1.44	2.03	2.87	3.52	4.06	4.98	5.75	6.42	7.87	-	-	-	
	10	V	V		1.60	2.26	3.19	3.91	4.51	5.53	6.39	7.14	8.74	-	-	-	
	12.5	V	V		2.00	2.82	3.99	4.89	5.64	6.91	7.98	8.92	10.93	-	-	-	
	15	V	V		2.39	3.39	4.79	5.87	6.77	8.29	9.58	10.71	13.11	-	-	-	
	20	V	V		3.19	4.51	6.39	7.82	9.03	11.06	12.77	14.28	17.49	-	-	-	
	25		V		3.99	5.64	7.98	9.78	11.29	13.82	15.96	17.85	21.86	-	-	-	
	30		V	V	4.79	6.77	9.58	11.73	13.54	16.59	19.16	21.42	26.23	-	-	-	
	35		V	V	5.59	7.90	11.17	13.69	15.80	19.35	22.35	24.99	30.60	-	-	-	
	40		V	V	6.39	9.03	12.77	15.64	18.06	22.12	25.54	28.55	34.97	-	-	-	
	50		V	V	7.98	11.29	15.96	19.55	22.57	27.65	31.93	35.69	43.72	-	-	-	
60			V	9.58	13.54	19.16	23.46	27.09	33.18	38.31	42.83	52.46	-	-	-		
80			V	12.77	18.06	25.54	31.38	36.12	44.24	51.08	57.11	69.94	-	-	-		
100			V	15.96	22.57	31.93	39.10	45.15	55.30	63.85	71.39	87.43	-	-	-		

※ For MPa / bar / psi units, please refer to LORRIC.com.

Spray Angle	Capacity Code	Thread Size			Capacity at Pressure									Average particle size (µm)	Min. Free Passage (mm)	Filter mesh
		1/8	1/4	3/8	0.5 kgf/cm ²	1.0 kgf/cm ²	2.0 kgf/cm ²	3.0 kgf/cm ²	4.0 kgf/cm ²	6.0 kgf/cm ²	8.0 kgf/cm ²	10.0 kgf/cm ²	15.0 kgf/cm ²			
50°	1	V	V		0.16	0.23	0.32	0.39	0.45	0.55	0.64	0.71	0.87	-	-	-
	2	V	V		0.32	0.45	0.64	0.78	0.90	1.11	1.28	1.43	1.75	-	-	-
	2.5	V	V		0.40	0.56	0.80	0.98	1.13	1.38	1.60	1.78	2.19	-	-	-
	3	V	V		0.48	0.68	0.96	1.17	1.35	1.66	1.92	2.14	2.62	-	-	-
	4	V	V		0.64	0.90	1.28	1.56	1.81	2.21	2.55	2.86	3.50	-	-	-
	5	V	V		0.80	1.13	1.60	1.96	2.26	2.76	3.19	3.57	4.37	-	-	-
	6	V	V		0.96	1.35	1.92	2.35	2.71	3.32	3.83	4.28	5.25	-	-	-
	7	V	V		1.12	1.58	2.23	2.74	3.16	3.87	4.47	5.00	6.12	-	-	-
	7.5	V	V		1.20	1.69	2.39	2.93	3.39	4.15	4.79	5.35	6.56	-	-	-
	8	V	V		1.28	1.81	2.55	3.13	3.61	4.42	5.11	5.71	6.99	-	-	-
	9	V	V		1.44	2.03	2.87	3.52	4.06	4.98	5.75	6.42	7.87	-	-	-
	10	V	V		1.60	2.26	3.19	3.91	4.51	5.53	6.39	7.14	8.74	-	-	-
	12.5	V	V		2.00	2.82	3.99	4.89	5.64	6.91	7.98	8.92	10.93	-	-	-
	15	V	V		2.39	3.39	4.79	5.87	6.77	8.29	9.58	10.71	13.11	-	-	-
	20	V	V		3.19	4.51	6.39	7.82	9.03	11.06	12.77	14.28	17.49	-	-	-
	25		V		3.99	5.64	7.98	9.78	11.29	13.82	15.96	17.85	21.86	-	-	-
	30		V	V	4.79	6.77	9.58	11.73	13.54	16.59	19.16	21.42	26.23	-	-	-
	35		V	V	5.59	7.90	11.17	13.69	15.80	19.35	22.35	24.99	30.60	-	-	-
	40		V	V	6.39	9.03	12.77	15.64	18.06	22.12	25.54	28.55	34.97	-	-	-
	50		V	V	7.98	11.29	15.96	19.55	22.57	27.65	31.93	35.69	43.72	-	-	-
60		V	V	9.58	13.54	19.16	23.46	27.09	33.18	38.31	42.83	52.46	-	-	-	
80		V	V	12.77	18.06	25.54	31.38	36.12	44.24	51.08	57.11	69.94	-	-	-	
100		V	V	15.96	22.57	31.93	39.10	45.15	55.30	63.85	71.39	87.43	-	-	-	
65°	1	V	V		0.16	0.23	0.32	0.39	0.45	0.55	0.64	0.71	0.87	140	0.2	200
	2	V	V		0.32	0.45	0.64	0.78	0.90	1.11	1.28	1.43	1.75	-	0.4	150
	2.5	V	V		0.40	0.56	0.80	0.98	1.13	1.38	1.60	1.78	2.19	-	0.6	100
	3	V	V		0.48	0.68	0.96	1.17	1.35	1.66	1.92	2.14	2.62	-	0.7	100
	4	V	V		0.64	0.90	1.28	1.56	1.81	2.21	2.55	2.86	3.50	-	0.8	50
	5	V	V		0.80	1.13	1.60	1.96	2.26	2.76	3.19	3.57	4.37	-	0.9	50
	6	V	V		0.96	1.35	1.92	2.35	2.71	3.32	3.83	4.28	5.25	230	0.9	50
	7	V	V		1.12	1.58	2.23	2.74	3.16	3.87	4.47	5.00	6.12	-	1.0	-
	7.5	V	V		1.20	1.69	2.39	2.93	3.39	4.15	4.79	5.35	6.56	-	1.0	-
	8	V	V		1.28	1.81	2.55	3.13	3.61	4.42	5.11	5.71	6.99	-	1.1	-
	9	V	V		1.44	2.03	2.87	3.52	4.06	4.98	5.75	6.42	7.87	-	1.1	-
	10	V	V		1.60	2.26	3.19	3.91	4.51	5.53	6.39	7.14	8.74	-	1.2	-
	12.5	V	V		2.00	2.82	3.99	4.89	5.64	6.91	7.98	8.92	10.93	-	1.3	-
	15	V	V		2.39	3.39	4.79	5.87	6.77	8.29	9.58	10.71	13.11	-	1.4	-
	20	V	V		3.19	4.51	6.39	7.82	9.03	11.06	12.77	14.28	17.49	370	1.6	-
	25		V		3.99	5.64	7.98	9.78	11.29	13.82	15.96	17.85	21.86	-	2.0	-
	30		V	V	4.79	6.77	9.58	11.73	13.54	16.59	19.16	21.42	26.23	-	2.3	-
	35		V	V	5.59	7.90	11.17	13.69	15.80	19.35	22.35	24.99	30.60	-	2.4	-
	40		V	V	6.39	9.03	12.77	15.64	18.06	22.12	25.54	28.55	34.97	-	2.5	-
	50		V	V	7.98	11.29	15.96	19.55	22.57	27.65	31.93	35.69	43.72	-	2.8	-
60		V	V	9.58	13.54	19.16	23.46	27.09	33.18	38.31	42.83	52.46	-	3.1	-	
80		V	V	12.77	18.06	25.54	31.38	36.12	44.24	51.08	57.11	69.94	-	3.3	-	
100		V	V	15.96	22.57	31.93	39.10	45.15	55.30	63.85	71.39	87.43	630	3.9	-	
80°	1	V	V		0.16	0.23	0.32	0.39	0.45	0.55	0.64	0.71	0.87	135	0.2	200
	2	V	V		0.32	0.45	0.64	0.78	0.90	1.11	1.28	1.43	1.75	-	0.3	150
	2.5	V	V		0.40	0.56	0.80	0.98	1.13	1.38	1.60	1.78	2.19	-	0.4	150
	3	V	V		0.48	0.68	0.96	1.17	1.35	1.66	1.92	2.14	2.62	-	0.4	150
	4	V	V		0.64	0.90	1.28	1.56	1.81	2.21	2.55	2.86	3.50	-	0.6	100
	5	V	V		0.80	1.13	1.60	1.96	2.26	2.76	3.19	3.57	4.37	220	0.7	50
	6	V	V		0.96	1.35	1.92	2.35	2.71	3.32	3.83	4.28	5.25	-	0.7	50
	7	V	V		1.12	1.58	2.23	2.74	3.16	3.87	4.47	5.00	6.12	-	0.9	50
	7.5	V	V		1.20	1.69	2.39	2.93	3.39	4.15	4.79	5.35	6.56	-	0.9	50
	8	V	V		1.28	1.81	2.55	3.13	3.61	4.42	5.11	5.71	6.99	-	1.0	-
	9	V	V		1.44	2.03	2.87	3.52	4.06	4.98	5.75	6.42	7.87	-	1.0	-
	10	V	V		1.60	2.26	3.19	3.91	4.51	5.53	6.39	7.14	8.74	-	1.1	-
	12.5	V	V		2.00	2.82	3.99	4.89	5.64	6.91	7.98	8.92	10.93	-	1.3	-
	15	V	V		2.39	3.39	4.79	5.87	6.77	8.29	9.58	10.71	13.11	-	1.4	-
	20	V	V		3.19	4.51	6.39	7.82	9.03	11.06	12.77	14.28	17.49	340	1.6	-
	25		V		3.99	5.64	7.98	9.78	11.29	13.82	15.96	17.85	21.86	-	1.9	-
	30		V	V	4.79	6.77	9.58	11.73	13.54	16.59	19.16	21.42	26.23	-	2.1	-
	35		V	V	5.59	7.90	11.17	13.69	15.80	19.35	22.35	24.99	30.60	-	2.3	-
	40		V	V	6.39	9.03	12.77	15.64	18.06	22.12	25.54	28.55	34.97	-	2.4	-
	50		V	V	7.98	11.29	15.96	19.55	22.57	27.65	31.93	35.69	43.72	-	2.8	-
60		V	V	9.58	13.54	19.16	23.46	27.09	33.18	38.31	42.83	52.46	-	2.5	-	
80		V	V	12.77	18.06	25.54	31.38	36.12	44.24	51.08	57.11	69.94	-	3.1	-	
100		V	V	15.96	22.57	31.93	39.10	45.15	55.30	63.85	71.39	87.43	600	3.7	-	

※ For MPa / bar / psi units, please refer to LORRIC.com.

Spray Angle	Capacity Code	Thread Size			Capacity at Pressure									Average particle size (um)	Min. Free Passage (mm)	Filter mesh
		1/8	1/4	3/8	0.5 kgf/cm ²	1.0 kgf/cm ²	2.0 kgf/cm ²	3.0 kgf/cm ²	4.0 kgf/cm ²	6.0 kgf/cm ²	8.0 kgf/cm ²	10.0 kgf/cm ²	15.0 kgf/cm ²			
90°	1	V	V		0.16	0.23	0.32	0.39	0.45	0.55	0.64	0.71	0.87	130	0.2	200
	2	V	V		0.32	0.45	0.64	0.78	0.90	1.11	1.28	1.43	1.75	-	0.3	150
	2.5	V	V		0.40	0.56	0.80	0.98	1.13	1.38	1.60	1.78	2.19	-	0.4	150
	3	V	V		0.48	0.68	0.96	1.17	1.35	1.66	1.92	2.14	2.62	-	0.4	150
	4	V	V		0.64	0.90	1.28	1.56	1.81	2.21	2.55	2.86	3.50	-	0.5	100
	5	V	V		0.80	1.13	1.60	1.96	2.26	2.76	3.19	3.57	4.37	-	0.5	100
	6	V	V		0.96	1.35	1.92	2.35	2.71	3.32	3.83	4.28	5.25	210	0.5	100
	7	V	V		1.12	1.58	2.23	2.74	3.16	3.87	4.47	5.00	6.12	-	0.6	100
	7.5	V	V		1.20	1.69	2.39	2.93	3.39	4.15	4.79	5.35	6.56	-	0.8	50
	8	V	V		1.28	1.81	2.55	3.13	3.61	4.42	5.11	5.71	6.99	330	0.8	50
	9	V	V		1.44	2.03	2.87	3.52	4.06	4.98	5.75	6.42	7.87	-	0.8	50
	10	V	V		1.60	2.26	3.19	3.91	4.51	5.53	6.39	7.14	8.74	-	1.0	-
	12.5	V	V		2.00	2.82	3.99	4.89	5.64	6.91	7.98	8.92	10.93	-	1.1	-
	15	V	V		2.39	3.39	4.79	5.87	6.77	8.29	9.58	10.71	13.11	-	1.2	-
	20	V	V		3.19	4.51	6.39	7.82	9.03	11.06	12.77	14.28	17.49	-	1.4	-
	25		V		3.99	5.64	7.98	9.78	11.29	13.82	15.96	17.85	21.86	-	1.6	-
	30		V	V	4.79	6.77	9.58	11.73	13.54	16.59	19.16	21.42	26.23	-	1.8	-
	35		V	V	5.59	7.90	11.17	13.69	15.80	19.35	22.35	24.99	30.60	-	2.0	-
	40		V	V	6.39	9.03	12.77	15.64	18.06	22.12	25.54	28.55	34.97	-	2.1	-
	50		V	V	7.98	11.29	15.96	19.55	22.57	27.65	31.93	35.69	43.72	-	2.3	-
60		V	V	9.58	13.54	19.16	23.46	27.09	33.18	38.31	42.83	52.46	-	2.5	-	
80		V	V	12.77	18.06	25.54	31.38	36.12	44.24	51.08	57.11	69.94	-	2.7	-	
100		V	V	15.96	22.57	31.93	39.10	45.15	55.30	63.85	71.39	87.43	570	3.3	-	
100°	1	V	V		0.16	0.23	0.32	0.39	0.45	0.55	0.64	0.71	0.87	-	-	-
	2	V	V		0.32	0.45	0.64	0.78	0.90	1.11	1.28	1.43	1.75	-	-	-
	2.5	V	V		0.40	0.56	0.80	0.98	1.13	1.38	1.60	1.78	2.19	-	-	-
	3	V	V		0.48	0.68	0.96	1.17	1.35	1.66	1.92	2.14	2.62	-	-	-
	4	V	V		0.64	0.90	1.28	1.56	1.81	2.21	2.55	2.86	3.50	-	-	-
	5	V	V		0.80	1.13	1.60	1.96	2.26	2.76	3.19	3.57	4.37	-	-	-
	6	V	V		0.96	1.35	1.92	2.35	2.71	3.32	3.83	4.28	5.25	-	-	-
	7	V	V		1.12	1.58	2.23	2.74	3.16	3.87	4.47	5.00	6.12	-	-	-
	7.5	V	V		1.20	1.69	2.39	2.93	3.39	4.15	4.79	5.35	6.56	-	-	-
	8	V	V		1.28	1.81	2.55	3.13	3.61	4.42	5.11	5.71	6.99	-	-	-
	9	V	V		1.44	2.03	2.87	3.52	4.06	4.98	5.75	6.42	7.87	-	-	-
	10	V	V		1.60	2.26	3.19	3.91	4.51	5.53	6.39	7.14	8.74	-	-	-
	12.5	V	V		2.00	2.82	3.99	4.89	5.64	6.91	7.98	8.92	10.93	-	-	-
	15	V	V		2.39	3.39	4.79	5.87	6.77	8.29	9.58	10.71	13.11	-	-	-
	20	V	V		3.19	4.51	6.39	7.82	9.03	11.06	12.77	14.28	17.49	-	-	-
	25		V		3.99	5.64	7.98	9.78	11.29	13.82	15.96	17.85	21.86	-	-	-
	30		V	V	4.79	6.77	9.58	11.73	13.54	16.59	19.16	21.42	26.23	-	-	-
	35		V	V	5.59	7.90	11.17	13.69	15.80	19.35	22.35	24.99	30.60	-	-	-
	40		V	V	6.39	9.03	12.77	15.64	18.06	22.12	25.54	28.55	34.97	-	-	-
	50		V	V	7.98	11.29	15.96	19.55	22.57	27.65	31.93	35.69	43.72	-	-	-
60		V	V	9.58	13.54	19.16	23.46	27.09	33.18	38.31	42.83	52.46	-	-	-	
80		V	V	12.77	18.06	25.54	31.38	36.12	44.24	51.08	57.11	69.94	-	-	-	
100		V	V	15.96	22.57	31.93	39.10	45.15	55.30	63.85	71.39	87.43	-	-	-	
110°	1	V	V		0.16	0.23	0.32	0.39	0.45	0.55	0.64	0.71	0.87	-	-	-
	2	V	V		0.32	0.45	0.64	0.78	0.90	1.11	1.28	1.43	1.75	-	-	-
	2.5	V	V		0.40	0.56	0.80	0.98	1.13	1.38	1.60	1.78	2.19	-	-	-
	3	V	V		0.48	0.68	0.96	1.17	1.35	1.66	1.92	2.14	2.62	-	-	-
	4	V	V		0.64	0.90	1.28	1.56	1.81	2.21	2.55	2.86	3.50	-	-	-
	5	V	V		0.80	1.13	1.60	1.96	2.26	2.76	3.19	3.57	4.37	-	-	-
	6	V	V		0.96	1.35	1.92	2.35	2.71	3.32	3.83	4.28	5.25	-	-	-
	7	V	V		1.12	1.58	2.23	2.74	3.16	3.87	4.47	5.00	6.12	-	-	-
	7.5	V	V		1.20	1.69	2.39	2.93	3.39	4.15	4.79	5.35	6.56	-	-	-
	8	V	V		1.28	1.81	2.55	3.13	3.61	4.42	5.11	5.71	6.99	-	-	-
	9	V	V		1.44	2.03	2.87	3.52	4.06	4.98	5.75	6.42	7.87	-	-	-
	10	V	V		1.60	2.26	3.19	3.91	4.51	5.53	6.39	7.14	8.74	-	-	-
	12.5	V	V		2.00	2.82	3.99	4.89	5.64	6.91	7.98	8.92	10.93	-	-	-
	15	V	V		2.39	3.39	4.79	5.87	6.77	8.29	9.58	10.71	13.11	-	-	-
	20	V	V		3.19	4.51	6.39	7.82	9.03	11.06	12.77	14.28	17.49	-	-	-
	25		V		3.99	5.64	7.98	9.78	11.29	13.82	15.96	17.85	21.86	-	-	-
	30		V	V	4.79	6.77	9.58	11.73	13.54	16.59	19.16	21.42	26.23	-	-	-
	35		V	V	5.59	7.90	11.17	13.69	15.80	19.35	22.35	24.99	30.60	-	-	-
	40		V	V	6.39	9.03	12.77	15.64	18.06	22.12	25.54	28.55	34.97	-	-	-
	50		V	V	7.98	11.29	15.96	19.55	22.57	27.65	31.93	35.69	43.72	-	-	-
60		V	V	9.58	13.54	19.16	23.46	27.09	33.18	38.31	42.83	52.46	-	-	-	
80		V	V	12.77	18.06	25.54	31.38	36.12	44.24	51.08	57.11	69.94	-	-	-	
100		V	V	15.96	22.57	31.93	39.10	45.15	55.30	63.85	71.39	87.43	-	-	-	

※ For MPa / bar / psi units, please refer to LORRIC.com.

V High chemical resistance plastic flat fan nozzle for small flow rate



【 Top view of nozzle spray pattern 】



【 Flow distribution 】

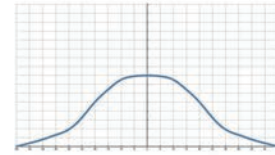

- Recommended working pressure: 3.0 kgf/cm²
- Flowrate tolerance: ± 5% @ 3.0 ± 0.1 kgf/cm²
- Angle tolerance: ± 5° @ 3.0 ± 0.1 kgf/cm²
- Jet angle tolerance: 3°

Features

- The spraying type is fan type, and the spray shape is single line. Both sides are tapered (tapered Edge), which presents a bell curve shape flow field distribution with weaker ends at the middle.
- One-piece design.
- For 1 kgf/cm² working pressure, customized design needed.
- PVDF is resistant to temperature and corrosive chemical solutions.

Applications

- Cleaning: Vehicles, containers, filters, dust, gravel, metals, metal parts, mechanical, steel plates, various containers, high pressure cleaning, wet processing, display panel, cleaning process for TFT-LCD manufacturing, machinery washing, etc.
- Cooling: Gas, tank, machinery, metal, roof, etc.
- Dispersion: Humidifying, chemicals (eg. etching solution, developer, insect repellent, etc.), firefighting, dedust, deodorization, etc.

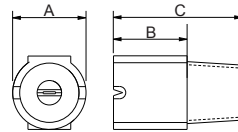

Appearance dimensions may vary depending on model, material. Please ask for details.

Material	Serie	Unit (mm)			Thread Type	Weight (g) PVDF
		A	B	C		
Plastic	1/4V	14	14	25	1/4M	4.0

Material

- Plastic: PVDF

How to place an order for LORRIC nozzles?

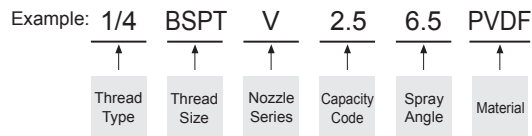

※ Standard Pressure: Column in red.
 ※ This product for spray angle 0°, 15° 25°, 40°, 50°, 100° and 110° is able to be made to order.

Spray Angle	Capacity Code	Thread Size			Capacity at Pressure										Average particle size (um)	Min. Free Passage (mm)	Filter mesh
		1/8	1/4	3/8	0.5 kgf/cm ²	1.0 kgf/cm ²	2.0 kgf/cm ²	3.0 kgf/cm ²	4.0 kgf/cm ²	6.0 kgf/cm ²	8.0 kgf/cm ²	10.0 kgf/cm ²	15.0 kgf/cm ²				
0°	1	V	V		0.16	0.23	0.32	0.39	0.45	0.55	0.64	0.71	0.87	-	-	-	
	2	V	V		0.32	0.45	0.64	0.78	0.90	1.11	1.28	1.43	1.75	-	-	-	
	2.5	V	V		0.40	0.56	0.80	0.98	1.13	1.38	1.60	1.78	2.19	-	-	-	
	3	V	V		0.48	0.68	0.96	1.17	1.35	1.66	1.92	2.14	2.62	-	-	-	
	4	V	V		0.64	0.90	1.28	1.56	1.81	2.21	2.55	2.86	3.50	-	-	-	
	5	V	V		0.80	1.13	1.60	1.96	2.26	2.76	3.19	3.57	4.37	-	-	-	
	6	V	V		0.96	1.35	1.92	2.35	2.71	3.32	3.83	4.28	5.25	-	-	-	
	7	V	V		1.12	1.58	2.23	2.74	3.16	3.87	4.47	5.00	6.12	-	-	-	
	7.5	V	V		1.20	1.69	2.39	2.93	3.39	4.15	4.79	5.35	6.56	-	-	-	
	8	V	V		1.28	1.81	2.55	3.13	3.61	4.42	5.11	5.71	6.99	-	-	-	
	9	V	V		1.44	2.03	2.87	3.52	4.06	4.98	5.75	6.42	7.87	-	-	-	
	10	V	V		1.60	2.26	3.19	3.91	4.51	5.53	6.39	7.14	8.74	-	-	-	
	12.5	V	V		2.00	2.82	3.99	4.89	5.64	6.91	7.98	8.92	10.93	-	-	-	
	15	V	V		2.39	3.39	4.79	5.87	6.77	8.29	9.58	10.71	13.11	-	-	-	
	20	V	V		3.19	4.51	6.39	7.82	9.03	11.06	12.77	14.28	17.49	-	-	-	
	25		V		3.99	5.64	7.98	9.78	11.29	13.82	15.96	17.85	21.86	-	-	-	
	30		V	V	4.79	6.77	9.58	11.73	13.54	16.59	19.16	21.42	26.23	-	-	-	
	35		V	V	5.59	7.90	11.17	13.69	15.80	19.35	22.35	24.99	30.60	-	-	-	
	40		V	V	6.39	9.03	12.77	15.64	18.06	22.12	25.54	28.55	34.97	-	-	-	
	50		V	V	7.98	11.29	15.96	19.55	22.57	27.65	31.93	35.69	43.72	-	-	-	
60			V	9.58	13.54	19.16	23.46	27.09	33.18	38.31	42.83	52.46	-	-	-		
80			V	12.77	18.06	25.54	31.38	36.12	44.24	51.08	57.11	69.94	-	-	-		
100			V	15.96	22.57	31.93	39.10	45.15	55.30	63.85	71.39	87.43	-	-	-		

※ For MPa / bar / psi units, please refer to LORRIC.com.

Spray Angle	Capacity Code	Thread Size			Capacity at Pressure									Average particle size (um)	Min. Free Passage (mm)	Filter mesh
		1/8	1/4	3/8	0.5 kgf/cm ²	1.0 kgf/cm ²	2.0 kgf/cm ²	3.0 kgf/cm ²	4.0 kgf/cm ²	6.0 kgf/cm ²	8.0 kgf/cm ²	10.0 kgf/cm ²	15.0 kgf/cm ²			
15°	1	V	V		0.16	0.23	0.32	0.39	0.45	0.55	0.64	0.71	0.87	-	-	-
	2	V	V		0.32	0.45	0.64	0.78	0.90	1.11	1.28	1.43	1.75	-	-	-
	2.5	V	V		0.40	0.56	0.80	0.98	1.13	1.38	1.60	1.78	2.19	-	-	-
	3	V	V		0.48	0.68	0.96	1.17	1.35	1.66	1.92	2.14	2.62	-	-	-
	4	V	V		0.64	0.90	1.28	1.56	1.81	2.21	2.55	2.86	3.50	-	-	-
	5	V	V		0.80	1.13	1.60	1.96	2.26	2.76	3.19	3.57	4.37	-	-	-
	6	V	V		0.96	1.35	1.92	2.35	2.71	3.32	3.83	4.28	5.25	-	-	-
	7	V	V		1.12	1.58	2.23	2.74	3.16	3.87	4.47	5.00	6.12	-	-	-
	7.5	V	V		1.20	1.69	2.39	2.93	3.39	4.15	4.79	5.35	6.56	-	-	-
	8	V	V		1.28	1.81	2.55	3.13	3.61	4.42	5.11	5.71	6.99	-	-	-
	9	V	V		1.44	2.03	2.87	3.52	4.06	4.98	5.75	6.42	7.87	-	-	-
	10	V	V		1.60	2.26	3.19	3.91	4.51	5.53	6.39	7.14	8.74	-	-	-
	12.5	V	V		2.00	2.82	3.99	4.89	5.64	6.91	7.98	8.92	10.93	-	-	-
	15	V	V		2.39	3.39	4.79	5.87	6.77	8.29	9.58	10.71	13.11	-	-	-
	20	V	V		3.19	4.51	6.39	7.82	9.03	11.06	12.77	14.28	17.49	-	-	-
	25		V		3.99	5.64	7.98	9.78	11.29	13.82	15.96	17.85	21.86	-	-	-
	30		V	V	4.79	6.77	9.58	11.73	13.54	16.59	19.16	21.42	26.23	-	-	-
	35		V	V	5.59	7.90	11.17	13.69	15.80	19.35	22.35	24.99	30.60	-	-	-
	40		V	V	6.39	9.03	12.77	15.64	18.06	22.12	25.54	28.55	34.97	-	-	-
	50		V	V	7.98	11.29	15.96	19.55	22.57	27.65	31.93	35.69	43.72	-	-	-
60			V	9.58	13.54	19.16	23.46	27.09	33.18	38.31	42.83	52.46	-	-	-	
80			V	12.77	18.06	25.54	31.38	36.12	44.24	51.08	57.11	69.94	-	-	-	
100			V	15.96	22.57	31.93	39.10	45.15	55.30	63.85	71.39	87.43	-	-	-	
25°	1	V	V		0.16	0.23	0.32	0.39	0.45	0.55	0.64	0.71	0.87	-	-	-
	2	V	V		0.32	0.45	0.64	0.78	0.90	1.11	1.28	1.43	1.75	-	-	-
	2.5	V	V		0.40	0.56	0.80	0.98	1.13	1.38	1.60	1.78	2.19	-	-	-
	3	V	V		0.48	0.68	0.96	1.17	1.35	1.66	1.92	2.14	2.62	-	-	-
	4	V	V		0.64	0.90	1.28	1.56	1.81	2.21	2.55	2.86	3.50	-	-	-
	5	V	V		0.80	1.13	1.60	1.96	2.26	2.76	3.19	3.57	4.37	-	-	-
	6	V	V		0.96	1.35	1.92	2.35	2.71	3.32	3.83	4.28	5.25	-	-	-
	7	V	V		1.12	1.58	2.23	2.74	3.16	3.87	4.47	5.00	6.12	-	-	-
	7.5	V	V		1.20	1.69	2.39	2.93	3.39	4.15	4.79	5.35	6.56	-	-	-
	8	V	V		1.28	1.81	2.55	3.13	3.61	4.42	5.11	5.71	6.99	-	-	-
	9	V	V		1.44	2.03	2.87	3.52	4.06	4.98	5.75	6.42	7.87	-	-	-
	10	V	V		1.60	2.26	3.19	3.91	4.51	5.53	6.39	7.14	8.74	-	-	-
	12.5	V	V		2.00	2.82	3.99	4.89	5.64	6.91	7.98	8.92	10.93	-	-	-
	15	V	V		2.39	3.39	4.79	5.87	6.77	8.29	9.58	10.71	13.11	-	-	-
	20	V	V		3.19	4.51	6.39	7.82	9.03	11.06	12.77	14.28	17.49	-	-	-
	25		V		3.99	5.64	7.98	9.78	11.29	13.82	15.96	17.85	21.86	-	-	-
	30		V	V	4.79	6.77	9.58	11.73	13.54	16.59	19.16	21.42	26.23	-	-	-
	35		V	V	5.59	7.90	11.17	13.69	15.80	19.35	22.35	24.99	30.60	-	-	-
	40		V	V	6.39	9.03	12.77	15.64	18.06	22.12	25.54	28.55	34.97	-	-	-
	50		V	V	7.98	11.29	15.96	19.55	22.57	27.65	31.93	35.69	43.72	-	-	-
60			V	9.58	13.54	19.16	23.46	27.09	33.18	38.31	42.83	52.46	-	-	-	
80			V	12.77	18.06	25.54	31.38	36.12	44.24	51.08	57.11	69.94	-	-	-	
100			V	15.96	22.57	31.93	39.10	45.15	55.30	63.85	71.39	87.43	-	-	-	
40°	1	V	V		0.16	0.23	0.32	0.39	0.45	0.55	0.64	0.71	0.87	-	-	-
	2	V	V		0.32	0.45	0.64	0.78	0.90	1.11	1.28	1.43	1.75	-	-	-
	2.5	V	V		0.40	0.56	0.80	0.98	1.13	1.38	1.60	1.78	2.19	-	-	-
	3	V	V		0.48	0.68	0.96	1.17	1.35	1.66	1.92	2.14	2.62	-	-	-
	4	V	V		0.64	0.90	1.28	1.56	1.81	2.21	2.55	2.86	3.50	-	-	-
	5	V	V		0.80	1.13	1.60	1.96	2.26	2.76	3.19	3.57	4.37	-	-	-
	6	V	V		0.96	1.35	1.92	2.35	2.71	3.32	3.83	4.28	5.25	-	-	-
	7	V	V		1.12	1.58	2.23	2.74	3.16	3.87	4.47	5.00	6.12	-	-	-
	7.5	V	V		1.20	1.69	2.39	2.93	3.39	4.15	4.79	5.35	6.56	-	-	-
	8	V	V		1.28	1.81	2.55	3.13	3.61	4.42	5.11	5.71	6.99	-	-	-
	9	V	V		1.44	2.03	2.87	3.52	4.06	4.98	5.75	6.42	7.87	-	-	-
	10	V	V		1.60	2.26	3.19	3.91	4.51	5.53	6.39	7.14	8.74	-	-	-
	12.5	V	V		2.00	2.82	3.99	4.89	5.64	6.91	7.98	8.92	10.93	-	-	-
	15	V	V		2.39	3.39	4.79	5.87	6.77	8.29	9.58	10.71	13.11	-	-	-
	20	V	V		3.19	4.51	6.39	7.82	9.03	11.06	12.77	14.28	17.49	-	-	-
	25		V		3.99	5.64	7.98	9.78	11.29	13.82	15.96	17.85	21.86	-	-	-
	30		V	V	4.79	6.77	9.58	11.73	13.54	16.59	19.16	21.42	26.23	-	-	-
	35		V	V	5.59	7.90	11.17	13.69	15.80	19.35	22.35	24.99	30.60	-	-	-
	40		V	V	6.39	9.03	12.77	15.64	18.06	22.12	25.54	28.55	34.97	-	-	-
	50		V	V	7.98	11.29	15.96	19.55	22.57	27.65	31.93	35.69	43.72	-	-	-
60			V	9.58	13.54	19.16	23.46	27.09	33.18	38.31	42.83	52.46	-	-	-	
80			V	12.77	18.06	25.54	31.38	36.12	44.24	51.08	57.11	69.94	-	-	-	
100			V	15.96	22.57	31.93	39.10	45.15	55.30	63.85	71.39	87.43	-	-	-	

※ For MPa / bar / psi units, please refer to LORRIC.com.

Spray Angle	Capacity Code	Thread Size			Capacity at Pressure										Average particle size (µm)	Min. Free Passage (mm)	Filter mesh
		1/8	1/4	3/8	0.5 kgf/cm ²	1.0 kgf/cm ²	2.0 kgf/cm ²	3.0 kgf/cm ²	4.0 kgf/cm ²	6.0 kgf/cm ²	8.0 kgf/cm ²	10.0 kgf/cm ²	15.0 kgf/cm ²				
50°	1	V	V		0.16	0.23	0.32	0.39	0.45	0.55	0.64	0.71	0.87	-	-	-	
	2	V	V		0.32	0.45	0.64	0.78	0.90	1.11	1.28	1.43	1.75	-	-	-	
	2.5	V	V		0.40	0.56	0.80	0.98	1.13	1.38	1.60	1.78	2.19	-	-	-	
	3	V	V		0.48	0.68	0.96	1.17	1.35	1.66	1.92	2.14	2.62	-	-	-	
	4	V	V		0.64	0.90	1.28	1.56	1.81	2.21	2.55	2.86	3.50	-	-	-	
	5	V	V		0.80	1.13	1.60	1.96	2.26	2.76	3.19	3.57	4.37	-	-	-	
	6	V	V		0.96	1.35	1.92	2.35	2.71	3.32	3.83	4.28	5.25	-	-	-	
	7	V	V		1.12	1.58	2.23	2.74	3.16	3.87	4.47	5.00	6.12	-	-	-	
	7.5	V	V		1.20	1.69	2.39	2.93	3.39	4.15	4.79	5.35	6.56	-	-	-	
	8	V	V		1.28	1.81	2.55	3.13	3.61	4.42	5.11	5.71	6.99	-	-	-	
	9	V	V		1.44	2.03	2.87	3.52	4.06	4.98	5.75	6.42	7.87	-	-	-	
	10	V	V		1.60	2.26	3.19	3.91	4.51	5.53	6.39	7.14	8.74	-	-	-	
	12.5	V	V		2.00	2.82	3.99	4.89	5.64	6.91	7.98	8.92	10.93	-	-	-	
	15	V	V		2.39	3.39	4.79	5.87	6.77	8.29	9.58	10.71	13.11	-	-	-	
	20	V	V		3.19	4.51	6.39	7.82	9.03	11.06	12.77	14.28	17.49	-	-	-	
	25		V		3.99	5.64	7.98	9.78	11.29	13.82	15.96	17.85	21.86	-	-	-	
	30		V	V	4.79	6.77	9.58	11.73	13.54	16.59	19.16	21.42	26.23	-	-	-	
	35		V	V	5.59	7.90	11.17	13.69	15.80	19.35	22.35	24.99	30.60	-	-	-	
	40		V	V	6.39	9.03	12.77	15.64	18.06	22.12	25.54	28.55	34.97	-	-	-	
	50		V	V	7.98	11.29	15.96	19.55	22.57	27.65	31.93	35.69	43.72	-	-	-	
60			V	9.58	13.54	19.16	23.46	27.09	33.18	38.31	42.83	52.46	-	-	-		
80			V	12.77	18.06	25.54	31.38	36.12	44.24	51.08	57.11	69.94	-	-	-		
100			V	15.96	22.57	31.93	39.10	45.15	55.30	63.85	71.39	87.43	-	-	-		
65°	1	V	V		0.16	0.23	0.32	0.39	0.45	0.55	0.64	0.71	0.87	140	0.2	200	
	2	V	V		0.32	0.45	0.64	0.78	0.90	1.11	1.28	1.43	1.75	-	0.4	150	
	2.5	V	V		0.40	0.56	0.80	0.98	1.13	1.38	1.60	1.78	2.19	-	0.6	100	
	3	V	V		0.48	0.68	0.96	1.17	1.35	1.66	1.92	2.14	2.62	-	0.7	100	
	4	V	V		0.64	0.90	1.28	1.56	1.81	2.21	2.55	2.86	3.50	-	0.8	50	
	5	V	V		0.80	1.13	1.60	1.96	2.26	2.76	3.19	3.57	4.37	-	0.9	50	
	6	V	V		0.96	1.35	1.92	2.35	2.71	3.32	3.83	4.28	5.25	230	0.9	50	
	7	V	V		1.12	1.58	2.23	2.74	3.16	3.87	4.47	5.00	6.12	-	1.0	-	
	7.5	V	V		1.20	1.69	2.39	2.93	3.39	4.15	4.79	5.35	6.56	-	1.0	-	
	8	V	V		1.28	1.81	2.55	3.13	3.61	4.42	5.11	5.71	6.99	-	1.1	-	
	9	V	V		1.44	2.03	2.87	3.52	4.06	4.98	5.75	6.42	7.87	-	1.1	-	
	10	V	V		1.60	2.26	3.19	3.91	4.51	5.53	6.39	7.14	8.74	-	1.2	-	
	12.5	V	V		2.00	2.82	3.99	4.89	5.64	6.91	7.98	8.92	10.93	-	1.3	-	
	15	V	V		2.39	3.39	4.79	5.87	6.77	8.29	9.58	10.71	13.11	-	1.4	-	
	20	V	V		3.19	4.51	6.39	7.82	9.03	11.06	12.77	14.28	17.49	370	1.6	-	
	25		V		3.99	5.64	7.98	9.78	11.29	13.82	15.96	17.85	21.86	-	2.0	-	
	30		V	V	4.79	6.77	9.58	11.73	13.54	16.59	19.16	21.42	26.23	-	2.3	-	
	35		V	V	5.59	7.90	11.17	13.69	15.80	19.35	22.35	24.99	30.60	-	2.4	-	
	40		V	V	6.39	9.03	12.77	15.64	18.06	22.12	25.54	28.55	34.97	-	2.5	-	
	50		V	V	7.98	11.29	15.96	19.55	22.57	27.65	31.93	35.69	43.72	-	2.8	-	
60			V	9.58	13.54	19.16	23.46	27.09	33.18	38.31	42.83	52.46	-	3.1	-		
80			V	12.77	18.06	25.54	31.38	36.12	44.24	51.08	57.11	69.94	-	3.3	-		
100			V	15.96	22.57	31.93	39.10	45.15	55.30	63.85	71.39	87.43	630	3.9	-		
80°	1	V	V		0.16	0.23	0.32	0.39	0.45	0.55	0.64	0.71	0.87	135	0.2	200	
	2	V	V		0.32	0.45	0.64	0.78	0.90	1.11	1.28	1.43	1.75	-	0.3	150	
	2.5	V	V		0.40	0.56	0.80	0.98	1.13	1.38	1.60	1.78	2.19	-	0.4	150	
	3	V	V		0.48	0.68	0.96	1.17	1.35	1.66	1.92	2.14	2.62	-	0.4	150	
	4	V	V		0.64	0.90	1.28	1.56	1.81	2.21	2.55	2.86	3.50	-	0.6	100	
	5	V	V		0.80	1.13	1.60	1.96	2.26	2.76	3.19	3.57	4.37	220	0.7	50	
	6	V	V		0.96	1.35	1.92	2.35	2.71	3.32	3.83	4.28	5.25	-	0.7	50	
	7	V	V		1.12	1.58	2.23	2.74	3.16	3.87	4.47	5.00	6.12	-	0.9	50	
	7.5	V	V		1.20	1.69	2.39	2.93	3.39	4.15	4.79	5.35	6.56	-	0.9	50	
	8	V	V		1.28	1.81	2.55	3.13	3.61	4.42	5.11	5.71	6.99	-	1.0	-	
	9	V	V		1.44	2.03	2.87	3.52	4.06	4.98	5.75	6.42	7.87	-	1.0	-	
	10	V	V		1.60	2.26	3.19	3.91	4.51	5.53	6.39	7.14	8.74	-	1.1	-	
	12.5	V	V		2.00	2.82	3.99	4.89	5.64	6.91	7.98	8.92	10.93	-	1.3	-	
	15	V	V		2.39	3.39	4.79	5.87	6.77	8.29	9.58	10.71	13.11	-	1.4	-	
	20	V	V		3.19	4.51	6.39	7.82	9.03	11.06	12.77	14.28	17.49	340	1.6	-	
	25		V		3.99	5.64	7.98	9.78	11.29	13.82	15.96	17.85	21.86	-	1.9	-	
	30		V	V	4.79	6.77	9.58	11.73	13.54	16.59	19.16	21.42	26.23	-	2.1	-	
	35		V	V	5.59	7.90	11.17	13.69	15.80	19.35	22.35	24.99	30.60	-	2.3	-	
	40		V	V	6.39	9.03	12.77	15.64	18.06	22.12	25.54	28.55	34.97	-	2.4	-	
	50		V	V	7.98	11.29	15.96	19.55	22.57	27.65	31.93	35.69	43.72	-	2.8	-	
60			V	9.58	13.54	19.16	23.46	27.09	33.18	38.31	42.83	52.46	-	2.5	-		
80			V	12.77	18.06	25.54	31.38	36.12	44.24	51.08	57.11	69.94	-	3.1	-		
100			V	15.96	22.57	31.93	39.10	45.15	55.30	63.85	71.39	87.43	600	3.7	-		

※ For MPa / bar / psi units, please refer to LORRIC.com.

Spray Angle	Capacity Code	Thread Size			Capacity at Pressure										Average particle size (um)	Min. Free Passage (mm)	Filter mesh
		1/8	1/4	3/8	0.5 kgf/cm ²	1.0 kgf/cm ²	2.0 kgf/cm ²	3.0 kgf/cm ²	4.0 kgf/cm ²	6.0 kgf/cm ²	8.0 kgf/cm ²	10.0 kgf/cm ²	15.0 kgf/cm ²				
90°	1	V	V		0.16	0.23	0.32	0.39	0.45	0.55	0.64	0.71	0.87	130	0.2	200	
	2	V	V		0.32	0.45	0.64	0.78	0.90	1.11	1.28	1.43	1.75	-	0.3	150	
	2.5	V	V		0.40	0.56	0.80	0.98	1.13	1.38	1.60	1.78	2.19	-	0.4	150	
	3	V	V		0.48	0.68	0.96	1.17	1.35	1.66	1.92	2.14	2.62	-	0.4	150	
	4	V	V		0.64	0.90	1.28	1.56	1.81	2.21	2.55	2.86	3.50	-	0.5	100	
	5	V	V		0.80	1.13	1.60	1.96	2.26	2.76	3.19	3.57	4.37	-	0.5	100	
	6	V	V		0.96	1.35	1.92	2.35	2.71	3.32	3.83	4.28	5.25	210	0.5	100	
	7	V	V		1.12	1.58	2.23	2.74	3.16	3.87	4.47	5.00	6.12	-	0.6	100	
	7.5	V	V		1.20	1.69	2.39	2.93	3.39	4.15	4.79	5.35	6.56	-	0.8	50	
	8	V	V		1.28	1.81	2.55	3.13	3.61	4.42	5.11	5.71	6.99	330	0.8	50	
	9	V	V		1.44	2.03	2.87	3.52	4.06	4.98	5.75	6.42	7.87	-	0.8	50	
	10	V	V		1.60	2.26	3.19	3.91	4.51	5.53	6.39	7.14	8.74	-	1.0	-	
	12.5	V	V		2.00	2.82	3.99	4.89	5.64	6.91	7.98	8.92	10.93	-	1.1	-	
	15	V	V		2.39	3.39	4.79	5.87	6.77	8.29	9.58	10.71	13.11	-	1.2	-	
	20	V	V		3.19	4.51	6.39	7.82	9.03	11.06	12.77	14.28	17.49	-	1.4	-	
	25		V		3.99	5.64	7.98	9.78	11.29	13.82	15.96	17.85	21.86	-	1.6	-	
	30		V	V	4.79	6.77	9.58	11.73	13.54	16.59	19.16	21.42	26.23	-	1.8	-	
	35		V	V	5.59	7.90	11.17	13.69	15.80	19.35	22.35	24.99	30.60	-	2.0	-	
	40		V	V	6.39	9.03	12.77	15.64	18.06	22.12	25.54	28.55	34.97	-	2.1	-	
	50		V	V	7.98	11.29	15.96	19.55	22.57	27.65	31.93	35.69	43.72	-	2.3	-	
60			V	9.58	13.54	19.16	23.46	27.09	33.18	38.31	42.83	52.46	-	2.5	-		
80			V	12.77	18.06	25.54	31.38	36.12	44.24	51.08	57.11	69.94	-	2.7	-		
100			V	15.96	22.57	31.93	39.10	45.15	55.30	63.85	71.39	87.43	570	3.3	-		
100°	1	V	V		0.16	0.23	0.32	0.39	0.45	0.55	0.64	0.71	0.87	-	-	-	
	2	V	V		0.32	0.45	0.64	0.78	0.90	1.11	1.28	1.43	1.75	-	-	-	
	2.5	V	V		0.40	0.56	0.80	0.98	1.13	1.38	1.60	1.78	2.19	-	-	-	
	3	V	V		0.48	0.68	0.96	1.17	1.35	1.66	1.92	2.14	2.62	-	-	-	
	4	V	V		0.64	0.90	1.28	1.56	1.81	2.21	2.55	2.86	3.50	-	-	-	
	5	V	V		0.80	1.13	1.60	1.96	2.26	2.76	3.19	3.57	4.37	-	-	-	
	6	V	V		0.96	1.35	1.92	2.35	2.71	3.32	3.83	4.28	5.25	-	-	-	
	7	V	V		1.12	1.58	2.23	2.74	3.16	3.87	4.47	5.00	6.12	-	-	-	
	7.5	V	V		1.20	1.69	2.39	2.93	3.39	4.15	4.79	5.35	6.56	-	-	-	
	8	V	V		1.28	1.81	2.55	3.13	3.61	4.42	5.11	5.71	6.99	-	-	-	
	9	V	V		1.44	2.03	2.87	3.52	4.06	4.98	5.75	6.42	7.87	-	-	-	
	10	V	V		1.60	2.26	3.19	3.91	4.51	5.53	6.39	7.14	8.74	-	-	-	
	12.5	V	V		2.00	2.82	3.99	4.89	5.64	6.91	7.98	8.92	10.93	-	-	-	
	15	V	V		2.39	3.39	4.79	5.87	6.77	8.29	9.58	10.71	13.11	-	-	-	
	20	V	V		3.19	4.51	6.39	7.82	9.03	11.06	12.77	14.28	17.49	-	-	-	
	25		V		3.99	5.64	7.98	9.78	11.29	13.82	15.96	17.85	21.86	-	-	-	
	30		V	V	4.79	6.77	9.58	11.73	13.54	16.59	19.16	21.42	26.23	-	-	-	
	35		V	V	5.59	7.90	11.17	13.69	15.80	19.35	22.35	24.99	30.60	-	-	-	
	40		V	V	6.39	9.03	12.77	15.64	18.06	22.12	25.54	28.55	34.97	-	-	-	
	50		V	V	7.98	11.29	15.96	19.55	22.57	27.65	31.93	35.69	43.72	-	-	-	
60			V	9.58	13.54	19.16	23.46	27.09	33.18	38.31	42.83	52.46	-	-	-		
80			V	12.77	18.06	25.54	31.38	36.12	44.24	51.08	57.11	69.94	-	-	-		
100			V	15.96	22.57	31.93	39.10	45.15	55.30	63.85	71.39	87.43	-	-	-		
110°	1	V	V		0.16	0.23	0.32	0.39	0.45	0.55	0.64	0.71	0.87	-	-	-	
	2	V	V		0.32	0.45	0.64	0.78	0.90	1.11	1.28	1.43	1.75	-	-	-	
	2.5	V	V		0.40	0.56	0.80	0.98	1.13	1.38	1.60	1.78	2.19	-	-	-	
	3	V	V		0.48	0.68	0.96	1.17	1.35	1.66	1.92	2.14	2.62	-	-	-	
	4	V	V		0.64	0.90	1.28	1.56	1.81	2.21	2.55	2.86	3.50	-	-	-	
	5	V	V		0.80	1.13	1.60	1.96	2.26	2.76	3.19	3.57	4.37	-	-	-	
	6	V	V		0.96	1.35	1.92	2.35	2.71	3.32	3.83	4.28	5.25	-	-	-	
	7	V	V		1.12	1.58	2.23	2.74	3.16	3.87	4.47	5.00	6.12	-	-	-	
	7.5	V	V		1.20	1.69	2.39	2.93	3.39	4.15	4.79	5.35	6.56	-	-	-	
	8	V	V		1.28	1.81	2.55	3.13	3.61	4.42	5.11	5.71	6.99	-	-	-	
	9	V	V		1.44	2.03	2.87	3.52	4.06	4.98	5.75	6.42	7.87	-	-	-	
	10	V	V		1.60	2.26	3.19	3.91	4.51	5.53	6.39	7.14	8.74	-	-	-	
	12.5	V	V		2.00	2.82	3.99	4.89	5.64	6.91	7.98	8.92	10.93	-	-	-	
	15	V	V		2.39	3.39	4.79	5.87	6.77	8.29	9.58	10.71	13.11	-	-	-	
	20	V	V		3.19	4.51	6.39	7.82	9.03	11.06	12.77	14.28	17.49	-	-	-	
	25		V		3.99	5.64	7.98	9.78	11.29	13.82	15.96	17.85	21.86	-	-	-	
	30		V	V	4.79	6.77	9.58	11.73	13.54	16.59	19.16	21.42	26.23	-	-	-	
	35		V	V	5.59	7.90	11.17	13.69	15.80	19.35	22.35	24.99	30.60	-	-	-	
	40		V	V	6.39	9.03	12.77	15.64	18.06	22.12	25.54	28.55	34.97	-	-	-	
	50		V	V	7.98	11.29	15.96	19.55	22.57	27.65	31.93	35.69	43.72	-	-	-	
60			V	9.58	13.54	19.16	23.46	27.09	33.18	38.31	42.83	52.46	-	-	-		
80			V	12.77	18.06	25.54	31.38	36.12	44.24	51.08	57.11	69.94	-	-	-		
100			V	15.96	22.57	31.93	39.10	45.15	55.30	63.85	71.39	87.43	-	-	-		

※ For MPa / bar / psi units, please refer to LORRIC.com.

CH Easy maintenance metal flat fan nozzle

Flat Fan Nozzles



【 Top view of nozzle spray pattern 】



【 Flow distribution 】

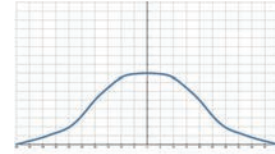

- Recommended working pressure: 3.0 kgf/cm²
- Flowrate tolerance: ± 5% @ 3.0 ± 0.1 kgf/cm²
- Angle tolerance: ± 5° @ 3.0 ± 0.1 kgf/cm²
- Jet angle tolerance: 3°

Features

- Spray type is fan type, spray shape is single-lined and tapering on both sides (Tapered Edge), which presents a bell curve shape flow field distribution with weaker ends at the middle.
- Three-piece structure facilitates maintenance cleaning and replacement, and can save the cost of replacing the nozzle head. Expenditure filter design, easy maintenance, reduced blocking, and reduced cleaning due to maintenance. When the hole is clogged, it may damage the nozzle hole.

- The fan nozzle angle can be 0°~110°, and the 0° spray angle spray pattern is a straight column type. The spray shape is a single point, which provides the best impact force among all nozzle types.

- When the fan nozzle is used in high pressure environment, HSS material (hardened stainless steel) must be selected. Operable at 200kgf/cm² pressure.

Applications

- Cleaning: Vehicles, Containers, Filters, Dust, Gravel, Metals, Metal Parts, Machinery, Steel Plates, Various Containers, High Pressure cleaning, Wet Processing, Display Pane, machine tool cleaning, etc.
- Cooling: Gas, tank, machinery, metal, roof, etc.
- Dispersion: Humidifying, chemicals (etching solution, Lubrication fluid, insect repellent fluid, etc.), Water Curtain. (fire protection, dust prevention, deodorization, etc.)

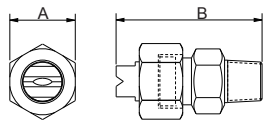

Appearance dimensions may vary depending on model, material. Please ask for details.

Material	Serie	Unit(mm)		Thread Type	Weight (g)		
		A	B		S303	S316	Brass
Metal	3/8CH	21	43	3/8M	70	71	77.2

Material

- Metal: Stainless 303, Stainless 316, BRASS

How to place an order for LORRIC nozzles?

Example: **1/4** **BSPT** **CH** **05** **90** **S316**

↑ ↑ ↑ ↑ ↑ ↑

Thread Thread Nozzle Capacity Spray Material

Type Size Series Code Angle

※ Standard Pressure: Column in red.
 ※ This product for spray angle 0°, 15° 25°, 40°, 50°, 100° and 110° is able to be made to order.

Spray Angle	Capacity Code	Capacity at Pressure									Average particle size (um)	Min. Free Passage (mm)	Filter mesh
		0.5 kgf/cm ²	1 kgf/cm ²	2 kgf/cm ²	3 kgf/cm ²	4 kgf/cm ²	6 kgf/cm ²	8 kgf/cm ²	10 kgf/cm ²	15 kgf/cm ²			
0°	1	0.16	0.23	0.32	0.39	0.45	0.55	0.64	0.71	0.87	-	-	-
	2	0.32	0.45	0.64	0.78	0.90	1.11	1.28	1.43	1.75	-	-	-
	2.5	0.40	0.56	0.80	0.98	1.13	1.38	1.60	1.78	2.19	-	-	-
	3	0.48	0.68	0.96	1.17	1.35	1.66	1.92	2.14	2.62	-	-	-
	4	0.64	0.90	1.28	1.56	1.81	2.21	2.55	2.86	3.50	-	-	-
	5	0.80	1.13	1.60	1.96	2.26	2.76	3.19	3.57	4.37	-	-	-
	6	0.96	1.35	1.92	2.35	2.71	3.32	3.83	4.28	5.25	-	-	-
	7	1.12	1.58	2.23	2.74	3.16	3.87	4.47	5.00	6.12	-	-	-
	7.5	1.20	1.69	2.39	2.93	3.39	4.15	4.79	5.35	6.56	-	-	-
	8	1.28	1.81	2.55	3.13	3.61	4.42	5.11	5.71	6.99	-	-	-
	9	1.44	2.03	2.87	3.52	4.06	4.98	5.75	6.42	7.87	-	-	-
	10	1.60	2.26	3.19	3.91	4.51	5.53	6.39	7.14	8.74	-	-	-
	12.5	2.00	2.82	3.99	4.89	5.64	6.91	7.98	8.92	10.93	-	-	-
	15	2.39	3.39	4.79	5.87	6.77	8.29	9.58	10.71	13.11	-	-	-
	20	3.19	4.51	6.39	7.82	9.03	11.06	12.77	14.28	17.49	-	-	-
25	3.99	5.64	7.98	9.78	11.29	13.82	15.96	17.85	21.86	-	-	-	
30	4.79	6.77	9.58	11.73	13.54	16.59	19.16	21.42	26.23	-	-	-	

※ For MPa / bar / psi units, please refer to LORRIC.com.

Spray Angle	Capacity Code	Capacity at Pressure									Average particle size (um)	Min. Free Passage (mm)	Filter mesh
		0.5 kgf/cm ²	1 kgf/cm ²	2 kgf/cm ²	3 kgf/cm ²	4 kgf/cm ²	6 kgf/cm ²	8 kgf/cm ²	10 kgf/cm ²	15 kgf/cm ²			
15°	1	0.16	0.23	0.32	0.39	0.45	0.55	0.64	0.71	0.87	-	-	-
	2	0.32	0.45	0.64	0.78	0.90	1.11	1.28	1.43	1.75	-	-	-
	2.5	0.40	0.56	0.80	0.98	1.13	1.38	1.60	1.78	2.19	-	-	-
	3	0.48	0.68	0.96	1.17	1.35	1.66	1.92	2.14	2.62	-	-	-
	4	0.64	0.90	1.28	1.56	1.81	2.21	2.55	2.86	3.50	-	-	-
	5	0.80	1.13	1.60	1.96	2.26	2.76	3.19	3.57	4.37	-	-	-
	6	0.96	1.35	1.92	2.35	2.71	3.32	3.83	4.28	5.25	-	-	-
	7	1.12	1.58	2.23	2.74	3.16	3.87	4.47	5.00	6.12	-	-	-
	7.5	1.20	1.69	2.39	2.93	3.39	4.15	4.79	5.35	6.56	-	-	-
	8	1.28	1.81	2.55	3.13	3.61	4.42	5.11	5.71	6.99	-	-	-
	9	1.44	2.03	2.87	3.52	4.06	4.98	5.75	6.42	7.87	-	-	-
	10	1.60	2.26	3.19	3.91	4.51	5.53	6.39	7.14	8.74	-	-	-
	12.5	2.00	2.82	3.99	4.89	5.64	6.91	7.98	8.92	10.93	-	-	-
	15	2.39	3.39	4.79	5.87	6.77	8.29	9.58	10.71	13.11	-	-	-
	20	3.19	4.51	6.39	7.82	9.03	11.06	12.77	14.28	17.49	-	-	-
25	3.99	5.64	7.98	9.78	11.29	13.82	15.96	17.85	21.86	-	-	-	
30	4.79	6.77	9.58	11.73	13.54	16.59	19.16	21.42	26.23	-	-	-	
25°	1	0.16	0.23	0.32	0.39	0.45	0.55	0.64	0.71	0.87	-	-	-
	2	0.32	0.45	0.64	0.78	0.90	1.11	1.28	1.43	1.75	-	-	-
	2.5	0.40	0.56	0.80	0.98	1.13	1.38	1.60	1.78	2.19	-	-	-
	3	0.48	0.68	0.96	1.17	1.35	1.66	1.92	2.14	2.62	-	-	-
	4	0.64	0.90	1.28	1.56	1.81	2.21	2.55	2.86	3.50	-	-	-
	5	0.80	1.13	1.60	1.96	2.26	2.76	3.19	3.57	4.37	-	-	-
	6	0.96	1.35	1.92	2.35	2.71	3.32	3.83	4.28	5.25	-	-	-
	7	1.12	1.58	2.23	2.74	3.16	3.87	4.47	5.00	6.12	-	-	-
	7.5	1.20	1.69	2.39	2.93	3.39	4.15	4.79	5.35	6.56	-	-	-
	8	1.28	1.81	2.55	3.13	3.61	4.42	5.11	5.71	6.99	-	-	-
	9	1.44	2.03	2.87	3.52	4.06	4.98	5.75	6.42	7.87	-	-	-
	10	1.60	2.26	3.19	3.91	4.51	5.53	6.39	7.14	8.74	-	-	-
	12.5	2.00	2.82	3.99	4.89	5.64	6.91	7.98	8.92	10.93	-	-	-
	15	2.39	3.39	4.79	5.87	6.77	8.29	9.58	10.71	13.11	-	-	-
	20	3.19	4.51	6.39	7.82	9.03	11.06	12.77	14.28	17.49	-	-	-
25	3.99	5.64	7.98	9.78	11.29	13.82	15.96	17.85	21.86	-	-	-	
30	4.79	6.77	9.58	11.73	13.54	16.59	19.16	21.42	26.23	-	-	-	
40°	1	0.16	0.23	0.32	0.39	0.45	0.55	0.64	0.71	0.87	-	-	-
	2	0.32	0.45	0.64	0.78	0.90	1.11	1.28	1.43	1.75	-	-	-
	2.5	0.40	0.56	0.80	0.98	1.13	1.38	1.60	1.78	2.19	-	-	-
	3	0.48	0.68	0.96	1.17	1.35	1.66	1.92	2.14	2.62	-	-	-
	4	0.64	0.90	1.28	1.56	1.81	2.21	2.55	2.86	3.50	-	-	-
	5	0.80	1.13	1.60	1.96	2.26	2.76	3.19	3.57	4.37	-	-	-
	6	0.96	1.35	1.92	2.35	2.71	3.32	3.83	4.28	5.25	-	-	-
	7	1.12	1.58	2.23	2.74	3.16	3.87	4.47	5.00	6.12	-	-	-
	7.5	1.20	1.69	2.39	2.93	3.39	4.15	4.79	5.35	6.56	-	-	-
	8	1.28	1.81	2.55	3.13	3.61	4.42	5.11	5.71	6.99	-	-	-
	9	1.44	2.03	2.87	3.52	4.06	4.98	5.75	6.42	7.87	-	-	-
	10	1.60	2.26	3.19	3.91	4.51	5.53	6.39	7.14	8.74	-	-	-
	12.5	2.00	2.82	3.99	4.89	5.64	6.91	7.98	8.92	10.93	-	-	-
	15	2.39	3.39	4.79	5.87	6.77	8.29	9.58	10.71	13.11	-	-	-
	20	3.19	4.51	6.39	7.82	9.03	11.06	12.77	14.28	17.49	-	-	-
25	3.99	5.64	7.98	9.78	11.29	13.82	15.96	17.85	21.86	-	-	-	
30	4.79	6.77	9.58	11.73	13.54	16.59	19.16	21.42	26.23	-	-	-	

※ For MPa / bar / psi units, please refer to LORRIC.com.

Spray Angle	Capacity Code	Capacity at Pressure									Average particle size (um)	Min. Free Passage (mm)	Filter mesh
		0.5 kgf/cm ²	1 kgf/cm ²	2 kgf/cm ²	3 kgf/cm ²	4 kgf/cm ²	6 kgf/cm ²	8 kgf/cm ²	10 kgf/cm ²	15 kgf/cm ²			
50°	1	0.16	0.23	0.32	0.39	0.45	0.55	0.64	0.71	0.87	-	-	-
	2	0.32	0.45	0.64	0.78	0.90	1.11	1.28	1.43	1.75	-	-	-
	2.5	0.40	0.56	0.80	0.98	1.13	1.38	1.60	1.78	2.19	-	-	-
	3	0.48	0.68	0.96	1.17	1.35	1.66	1.92	2.14	2.62	-	-	-
	4	0.64	0.90	1.28	1.56	1.81	2.21	2.55	2.86	3.50	-	-	-
	5	0.80	1.13	1.60	1.96	2.26	2.76	3.19	3.57	4.37	-	-	-
	6	0.96	1.35	1.92	2.35	2.71	3.32	3.83	4.28	5.25	-	-	-
	7	1.12	1.58	2.23	2.74	3.16	3.87	4.47	5.00	6.12	-	-	-
	7.5	1.20	1.69	2.39	2.93	3.39	4.15	4.79	5.35	6.56	-	-	-
	8	1.28	1.81	2.55	3.13	3.61	4.42	5.11	5.71	6.99	-	-	-
	9	1.44	2.03	2.87	3.52	4.06	4.98	5.75	6.42	7.87	-	-	-
	10	1.60	2.26	3.19	3.91	4.51	5.53	6.39	7.14	8.74	-	-	-
	12.5	2.00	2.82	3.99	4.89	5.64	6.91	7.98	8.92	10.93	-	-	-
	15	2.39	3.39	4.79	5.87	6.77	8.29	9.58	10.71	13.11	-	-	-
	20	3.19	4.51	6.39	7.82	9.03	11.06	12.77	14.28	17.49	-	-	-
	25	3.99	5.64	7.98	9.78	11.29	13.82	15.96	17.85	21.86	-	-	-
30	4.79	6.77	9.58	11.73	13.54	16.59	19.16	21.42	26.23	-	-	-	
65°	1	0.16	0.23	0.32	0.39	0.45	0.55	0.64	0.71	0.87	140	0.2	200
	2	0.32	0.45	0.64	0.78	0.90	1.11	1.28	1.43	1.75	-	0.4	150
	2.5	0.40	0.56	0.80	0.98	1.13	1.38	1.60	1.78	2.19	-	0.6	100
	3	0.48	0.68	0.96	1.17	1.35	1.66	1.92	2.14	2.62	-	0.7	100
	4	0.64	0.90	1.28	1.56	1.81	2.21	2.55	2.86	3.50	-	0.8	50
	5	0.80	1.13	1.60	1.96	2.26	2.76	3.19	3.57	4.37	-	0.9	50
	6	0.96	1.35	1.92	2.35	2.71	3.32	3.83	4.28	5.25	230	0.9	50
	7	1.12	1.58	2.23	2.74	3.16	3.87	4.47	5.00	6.12	-	1.0	-
	7.5	1.20	1.69	2.39	2.93	3.39	4.15	4.79	5.35	6.56	-	1.0	-
	8	1.28	1.81	2.55	3.13	3.61	4.42	5.11	5.71	6.99	-	1.1	-
	9	1.44	2.03	2.87	3.52	4.06	4.98	5.75	6.42	7.87	-	1.1	-
	10	1.60	2.26	3.19	3.91	4.51	5.53	6.39	7.14	8.74	-	1.2	-
	12.5	2.00	2.82	3.99	4.89	5.64	6.91	7.98	8.92	10.93	-	1.3	-
	15	2.39	3.39	4.79	5.87	6.77	8.29	9.58	10.71	13.11	-	1.4	-
	20	3.19	4.51	6.39	7.82	9.03	11.06	12.77	14.28	17.49	370	1.6	-
	25	3.99	5.64	7.98	9.78	11.29	13.82	15.96	17.85	21.86	-	2.0	-
30	4.79	6.77	9.58	11.73	13.54	16.59	19.16	21.42	26.23	-	2.3	-	
80°	1	0.16	0.23	0.32	0.39	0.45	0.55	0.64	0.71	0.87	135	0.2	200
	2	0.32	0.45	0.64	0.78	0.90	1.11	1.28	1.43	1.75	-	0.3	150
	2.5	0.40	0.56	0.80	0.98	1.13	1.38	1.60	1.78	2.19	-	0.4	150
	3	0.48	0.68	0.96	1.17	1.35	1.66	1.92	2.14	2.62	-	0.4	150
	4	0.64	0.90	1.28	1.56	1.81	2.21	2.55	2.86	3.50	-	0.6	100
	5	0.80	1.13	1.60	1.96	2.26	2.76	3.19	3.57	4.37	220	0.7	50
	6	0.96	1.35	1.92	2.35	2.71	3.32	3.83	4.28	5.25	-	0.7	50
	7	1.12	1.58	2.23	2.74	3.16	3.87	4.47	5.00	6.12	-	0.9	50
	7.5	1.20	1.69	2.39	2.93	3.39	4.15	4.79	5.35	6.56	-	0.9	50
	8	1.28	1.81	2.55	3.13	3.61	4.42	5.11	5.71	6.99	-	1.0	-
	9	1.44	2.03	2.87	3.52	4.06	4.98	5.75	6.42	7.87	-	1.0	-
	10	1.60	2.26	3.19	3.91	4.51	5.53	6.39	7.14	8.74	-	1.1	-
	12.5	2.00	2.82	3.99	4.89	5.64	6.91	7.98	8.92	10.93	-	1.3	-
	15	2.39	3.39	4.79	5.87	6.77	8.29	9.58	10.71	13.11	-	1.4	-
	20	3.19	4.51	6.39	7.82	9.03	11.06	12.77	14.28	17.49	340	1.6	-
	25	3.99	5.64	7.98	9.78	11.29	13.82	15.96	17.85	21.86	-	1.9	-
30	4.79	6.77	9.58	11.73	13.54	16.59	19.16	21.42	26.23	-	2.1	-	

※ For MPa / bar / psi units, please refer to LORRIC.com.

Spray Angle	Capacity Code	Capacity at Pressure									Average particle size (µm)	Min. Free Passage (mm)	Filter mesh
		0.5 kgf/cm ²	1 kgf/cm ²	2 kgf/cm ²	3 kgf/cm ²	4 kgf/cm ²	6 kgf/cm ²	8 kgf/cm ²	10 kgf/cm ²	15 kgf/cm ²			
90°	1	0.16	0.23	0.32	0.39	0.45	0.55	0.64	0.71	0.87	130	0.2	200
	2	0.32	0.45	0.64	0.78	0.90	1.11	1.28	1.43	1.75	-	0.3	150
	2.5	0.40	0.56	0.80	0.98	1.13	1.38	1.60	1.78	2.19	-	0.4	150
	3	0.48	0.68	0.96	1.17	1.35	1.66	1.92	2.14	2.62	-	0.4	150
	4	0.64	0.90	1.28	1.56	1.81	2.21	2.55	2.86	3.50	-	0.5	100
	5	0.80	1.13	1.60	1.96	2.26	2.76	3.19	3.57	4.37	-	0.5	100
	6	0.96	1.35	1.92	2.35	2.71	3.32	3.83	4.28	5.25	210	0.5	100
	7	1.12	1.58	2.23	2.74	3.16	3.87	4.47	5.00	6.12	-	0.6	100
	7.5	1.20	1.69	2.39	2.93	3.39	4.15	4.79	5.35	6.56	-	0.8	50
	8	1.28	1.81	2.55	3.13	3.61	4.42	5.11	5.71	6.99	330	0.8	50
	9	1.44	2.03	2.87	3.52	4.06	4.98	5.75	6.42	7.87	-	0.8	50
	10	1.60	2.26	3.19	3.91	4.51	5.53	6.39	7.14	8.74	-	1.0	-
	12.5	2.00	2.82	3.99	4.89	5.64	6.91	7.98	8.92	10.93	-	1.1	-
	15	2.39	3.39	4.79	5.87	6.77	8.29	9.58	10.71	13.11	-	1.2	-
	20	3.19	4.51	6.39	7.82	9.03	11.06	12.77	14.28	17.49	-	1.4	-
	25	3.99	5.64	7.98	9.78	11.29	13.82	15.96	17.85	21.86	-	1.6	-
30	4.79	6.77	9.58	11.73	13.54	16.59	19.16	21.42	26.23	-	1.8	-	
100°	1	0.16	0.23	0.32	0.39	0.45	0.55	0.64	0.71	0.87	-	-	-
	2	0.32	0.45	0.64	0.78	0.90	1.11	1.28	1.43	1.75	-	-	-
	2.5	0.40	0.56	0.80	0.98	1.13	1.38	1.60	1.78	2.19	-	-	-
	3	0.48	0.68	0.96	1.17	1.35	1.66	1.92	2.14	2.62	-	-	-
	4	0.64	0.90	1.28	1.56	1.81	2.21	2.55	2.86	3.50	-	-	-
	5	0.80	1.13	1.60	1.96	2.26	2.76	3.19	3.57	4.37	-	-	-
	6	0.96	1.35	1.92	2.35	2.71	3.32	3.83	4.28	5.25	-	-	-
	7	1.12	1.58	2.23	2.74	3.16	3.87	4.47	5.00	6.12	-	-	-
	7.5	1.20	1.69	2.39	2.93	3.39	4.15	4.79	5.35	6.56	-	-	-
	8	1.28	1.81	2.55	3.13	3.61	4.42	5.11	5.71	6.99	-	-	-
	9	1.44	2.03	2.87	3.52	4.06	4.98	5.75	6.42	7.87	-	-	-
	10	1.60	2.26	3.19	3.91	4.51	5.53	6.39	7.14	8.74	-	-	-
	12.5	2.00	2.82	3.99	4.89	5.64	6.91	7.98	8.92	10.93	-	-	-
	15	2.39	3.39	4.79	5.87	6.77	8.29	9.58	10.71	13.11	-	-	-
	20	3.19	4.51	6.39	7.82	9.03	11.06	12.77	14.28	17.49	-	-	-
	25	3.99	5.64	7.98	9.78	11.29	13.82	15.96	17.85	21.86	-	-	-
30	4.79	6.77	9.58	11.73	13.54	16.59	19.16	21.42	26.23	-	-	-	
110°	1	0.16	0.23	0.32	0.39	0.45	0.55	0.64	0.71	0.87	-	-	-
	2	0.32	0.45	0.64	0.78	0.90	1.11	1.28	1.43	1.75	-	-	-
	2.5	0.40	0.56	0.80	0.98	1.13	1.38	1.60	1.78	2.19	-	-	-
	3	0.48	0.68	0.96	1.17	1.35	1.66	1.92	2.14	2.62	-	-	-
	4	0.64	0.90	1.28	1.56	1.81	2.21	2.55	2.86	3.50	-	-	-
	5	0.80	1.13	1.60	1.96	2.26	2.76	3.19	3.57	4.37	-	-	-
	6	0.96	1.35	1.92	2.35	2.71	3.32	3.83	4.28	5.25	-	-	-
	7	1.12	1.58	2.23	2.74	3.16	3.87	4.47	5.00	6.12	-	-	-
	7.5	1.20	1.69	2.39	2.93	3.39	4.15	4.79	5.35	6.56	-	-	-
	8	1.28	1.81	2.55	3.13	3.61	4.42	5.11	5.71	6.99	-	-	-
	9	1.44	2.03	2.87	3.52	4.06	4.98	5.75	6.42	7.87	-	-	-
	10	1.60	2.26	3.19	3.91	4.51	5.53	6.39	7.14	8.74	-	-	-
	12.5	2.00	2.82	3.99	4.89	5.64	6.91	7.98	8.92	10.93	-	-	-
	15	2.39	3.39	4.79	5.87	6.77	8.29	9.58	10.71	13.11	-	-	-
	20	3.19	4.51	6.39	7.82	9.03	11.06	12.77	14.28	17.49	-	-	-
	25	3.99	5.64	7.98	9.78	11.29	13.82	15.96	17.85	21.86	-	-	-
30	4.79	6.77	9.58	11.73	13.54	16.59	19.16	21.42	26.23	-	-	-	

※ For MPa / bar / psi units, please refer to LORRIC.com.

PF Low pressure and wide angle plastic flat fan flood nozzle



【 Top view of nozzle spray pattern 】



【 Flow distribution 】

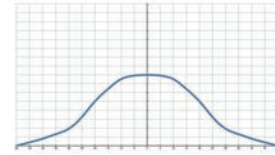

- Recommended working pressure: 1.5 kgf/cm²
- Flowrate tolerance: ± 10% @ 1.5 ± 0.1 kgf/cm²
- Angle tolerance: ± 10° @ 1.5 ± 0.1 kgf/cm²

Features

- The spray pattern is fan type, and the spray shape is single-line.
- Low-pressure wide-angle nozzle realizes a large angle coverage under 1.5kgf/cm² pressure, which is lower than standard fan type 3kgf/cm² operating pressure and is more suitable for low-pressure working environment.
- Spray the nozzle at an angle of 75° with respect to the axis of the nozzle. Check that the environment is suitable.
- The hooked nozzle tip is designed to reflect the water into a fan shape nozzle and greaten particle passage to prevent clogging.
- Operation pressure is greater than 4kgf/cm² may cause the liquid to overflow without fogging.

Applications

- Cleaning: Conveyor belt, film, copper, paper, glass, All kinds of plates, filters, dust and debris, machine tool cleaning.
- Cooling: Conveyor belts, tanks, machinery, metal, roofs, etc.
- Dispersion: Humidifying, Chemicals, Water Curtain (fire, dust, deodorization, etc.), defoaming, etc.

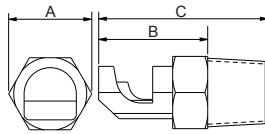

Appearance dimensions may vary depending on model, material. Please ask for details.

Material	Serie	Unit (mm)			Thread Type	Weight (g)	
		A	B	C		PVDF	PP
Plastic	1/8PF	10	15	23	1/8M	1.6	0.8
	1/4PF	14	17	28	1/4M	4.8	2.4

How to place an order for LORRIC nozzles?

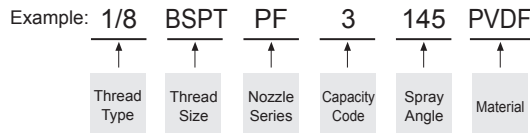

※ Standard Pressure: Column in red.

Material

- Plastic: PP, PVDF

Spray Angle	Capacity Code	Thread Size		Capacity at Pressure									Average particle size (um)	Min. Free Passage (mm)	Filter mesh
		1/8	1/4	0.5 kgf/cm ²	0.7 kgf/cm ²	1 kgf/cm ²	1.5 kgf/cm ²	2 kgf/cm ²	2.5 kgf/cm ²	3 kgf/cm ²	4 kgf/cm ²	6 kgf/cm ²			
-	0.5	V		0.16	0.19	0.23	0.28	0.32	0.36	0.40	0.46	0.56	150	0.5	100
	0.75	V		0.24	0.29	0.34	0.42	0.48	0.54	0.59	0.69	0.84	-	0.7	50
145°	1	V		0.32	0.38	0.46	0.56	0.65	0.72	0.79	0.91	1.12	-	0.8	50
-	1.25	V		0.40	0.48	0.57	0.70	0.81	0.90	0.99	1.14	1.40	-	0.8	50
	1.5	V		0.48	0.57	0.69	0.84	0.97	1.08	1.19	1.37	1.68	-	0.8	50
160°	1.75	V		0.57	0.67	0.80	0.98	1.13	1.27	1.39	1.60	1.96	-	1	-
-	2	V	V	0.65	0.77	0.91	1.12	1.29	1.45	1.58	1.83	2.24	200	1.1	-
	2.5	V	V	0.81	0.96	1.14	1.40	1.62	1.81	1.98	2.29	2.80	-	1.3	-
145°	3	V	V	0.97	1.15	1.37	1.68	1.94	2.17	2.38	2.74	3.36	-	1.4	-
	4	V	V	1.29	1.53	1.83	2.24	2.59	2.89	3.17	3.66	4.48	-	1.7	-
	5	V	V	1.62	1.91	2.29	2.80	3.23	3.61	3.96	4.57	5.60	-	1.7	-
	6	V	V	1.94	2.30	2.74	3.36	3.88	4.34	4.75	5.49	6.72	-	2	-
	7	V	V	2.26	2.68	3.20	3.92	4.53	5.06	5.54	6.40	7.84	350	2.2	-
	7.5	V	V	2.42	2.87	3.43	4.20	4.85	5.42	5.94	6.86	8.40	-	2.3	-
	8	V	V	2.59	3.06	3.66	4.48	5.17	5.78	6.34	7.32	8.96	-	2.4	-
	9	V	V	2.91	3.44	4.12	5.04	5.82	6.51	7.13	8.23	10.08	-	2.5	-
	10	V	V	3.23	3.83	4.57	5.60	6.47	7.23	7.92	9.14	11.20	-	2.6	-
	12.5	V	V	4.04	4.78	5.72	7.00	8.08	9.04	9.90	11.43	14.00	-	2.9	-
-	15	V	V	4.85	5.74	6.86	8.40	9.70	10.84	11.88	13.72	16.80	-	3.3	-
	20	V	V	6.47	7.65	9.14	11.20	12.93	14.46	15.84	18.29	22.40	410	3.5	-

※ For MPa / bar / psi units, please refer to LORRIC.com.

F Low pressure and wide angle metal flat fan flood nozzle

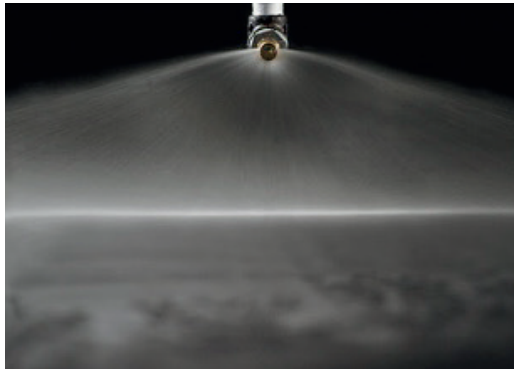

- Recommended working pressure: 1.5 kgf/cm²
- Flowrate tolerance: ± 10% @ 1.5 ± 0.1 kgf/cm²
- Angle tolerance: ± 10° @ 1.5 ± 0.1 kgf/cm²

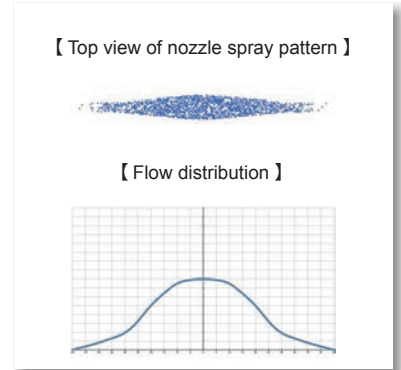

Flat Fan Nozzles

Features

- The spray pattern is fan type and the spray shape is single.
- Low-pressure wide-angle nozzle realizes a large-angle coverage area under 1.5kgf/cm² pressure, which is lower than standard fan type 3kgf/cm² operating pressure, and is more suitable for low-pressure working environment.
- Spray the nozzle at an angle of 75° with respect to the axis of the nozzle. Check that the environment is suitable.
- The hooked nozzle tip is designed to reflect the water into a fan shape nozzle and greaten particle passage to prevent clogging.
- Operation pressure is greater than 4kgf/cm² may cause the liquid to overflow without fogging.

Applications

- Cleaning: Conveyor belt, film, copper thin, paper, glass plate, all kinds of plates, filters, dust and gravel, and machine tool cleaning.
- Cooling: Conveyor belts, tanks, machinery, metal, roofs, etc.
- Dispersion: Humidifying, chemicals, Water Curtain (fire, dust, deodorization), defoaming, etc.

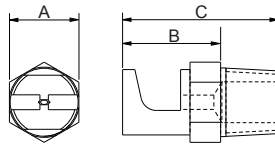

Appearance dimensions may vary depending on model, material. Please ask for details.

Material	Serie	Unit (mm)			Thread Type	Weight (g)			
		A	B	C		S303	S316	Brass	PVC
Metal	1/8F	10	15	23	1/8M	7.4	9.2	12.2	-
	1/4F	14	17	28	1/4M	23.8	20.4	21.8	-
	3/8F	17	24	39	3/8M	42.8	43	47	-
Plastic	1/8F	12	18	24	1/8M	-	-	-	1.6
	1/4F	-	-	-	1/4M	-	-	-	3.5
	3/8F	-	-	-	3/8M	-	-	-	8.2

Material

- Metal: Stainless 303, Stainless 316, BRASS
- Plastic: PVC

How to place an order for LORRIC nozzles?

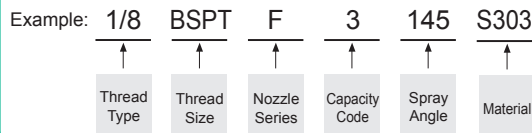

※ Standard Pressure: Column in red.

Spray Angle	Capacity Code	Thread Size			Capacity at Pressure								Average particle size (um)	Min. Free Passage (mm)	Filter mesh
		1/8	1/4	3/8	0.7 kgf/cm ²	1 kgf/cm ²	1.5 kgf/cm ²	2 kgf/cm ²	2.5 kgf/cm ²	3 kgf/cm ²	4 kgf/cm ²	6 kgf/cm ²			
125°	0.5	V			0.19	0.23	0.28	0.32	0.36	0.40	0.46	0.56	150	0.5	100
-	0.75	V			0.29	0.34	0.42	0.48	0.54	0.59	0.69	0.84	-	0.7	50
120°	1	V			0.38	0.46	0.56	0.65	0.72	0.79	0.91	1.12	-	0.8	50
-	1.25	V			0.48	0.57	0.70	0.81	0.90	0.99	1.14	1.40	-	0.8	50
	1.5	V			0.57	0.69	0.84	0.97	1.08	1.19	1.37	1.68	-	0.8	50
	1.75	V			0.67	0.80	0.98	1.13	1.27	1.39	1.60	1.96	-	1	-
	2	V	V		0.77	0.91	1.12	1.29	1.45	1.58	1.83	2.24	200	1.1	-
	2.5	V	V		0.96	1.14	1.40	1.62	1.81	1.98	2.29	2.80	-	1.3	-
	3	V	V		1.15	1.37	1.68	1.94	2.17	2.38	2.74	3.36	-	1.4	-
-	4	V	V		1.53	1.83	2.24	2.59	2.89	3.17	3.66	4.48	-	1.7	-
	170°	5	V	V	1.91	2.29	2.80	3.23	3.61	3.96	4.57	5.60	-	1.7	-
	-	6	V	V	2.30	2.74	3.36	3.88	4.34	4.75	5.49	6.72	-	2	-
	-	7	V	V	2.68	3.20	3.92	4.53	5.06	5.54	6.40	7.84	350	2.2	-
-	7.5	V	V		2.87	3.43	4.20	4.85	5.42	5.94	6.86	8.40	-	2.3	-
	8	V	V		3.06	3.66	4.48	5.17	5.78	6.34	7.32	8.96	-	2.4	-
	9	V	V		3.44	4.12	5.04	5.82	6.51	7.13	8.23	10.08	-	2.5	-
160°	10	V	V		3.83	4.57	5.60	6.47	7.23	7.92	9.14	11.20	-	2.6	-
	-	12.5	V	V		4.78	5.72	7.00	8.08	9.04	9.90	11.43	14.00	-	2.9
160°	15	V	V		5.74	6.86	8.40	9.70	10.84	11.88	13.72	16.80	-	3.3	-
	-	20	V	V	V	7.65	9.14	11.20	12.93	14.46	15.84	18.29	22.40	410	3.5
-	30			V	11.48	13.72	16.80	19.40	21.69	23.76	27.43	33.60	600	4.3	-

※ For MPa / bar / psi units, please refer to LORRIC.com.

QFH

High chemical resistance plastic easy install flat fan nozzle



【 Top view of nozzle spray pattern 】



【 Flow distribution 】

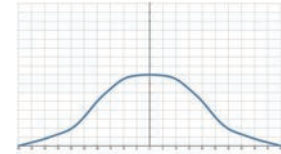

- Recommended working pressure: 3.0 kgf/cm²
- Flowrate tolerance: ± 5% @ 3.0 ± 0.1 kgf/cm²
- Angle tolerance: ± 5° @ 3.0 ± 0.1 kgf/cm²
- Jet angle tolerance: 3°

Features

- The spraying type is fan type, and the spray shape is single line and two sides are tapered (tapered edge), which presents a bell curve shape flow field distribution with weaker ends compared to the middle. Products with special flow field distribution can be customized.
- Two-piece quick-release design is divided into two parts: the nozzle and the body. It can be installed and removed without any tools. It is convenient for on-site operation. With three positioning buckle points, the nozzle can be accurately screwed

in and positioned to avoid loose nozzles and to ensure the quality of production.

- The internal gaskets have different options such as EPDM, Viton and Viton-F, which can be adapted to various chemical processes. With a special structural design, the nozzles and the base can be closely fitted to avoid water leakage.
- PVDF is resistant to temperature and corrosive chemical solutions.

Applications

- Cleaning: Vehicles, Containers, Filters, Dust, Gravel, Metals, Metal Parts, Machinery, Steel Plates, Various Containers, High Pressure Cleaning, Wet Processing, Display Pane, machine tool cleaning, etc.
- Cooling: Gas, tank, machinery, metal, roof, etc.
- Dispersion: Humidifying, chemicals (etching solution, Lubrication fluid, insect repellent fluid, etc.), Water Curtain (fire protection, dust prevention, deodorization, etc.).

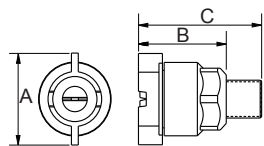

Appearance dimensions may vary depending on model, material. Please ask for details.

Material	Serie	Unit (mm)			Thread Type	Weight (g)
		A	B	C		
Plastic	1/8QFH	32	28	39	1/8M	17.2
	1/4QFH	32	28	43	1/4M	17.6
	3/8QFH	32	28	43	3/8M	19.3

Material

- TIP: PVDF
- Oring: EPDM, VITON
- Base: PVDF, PP, U-PVC (QFSA, QFWG)

How to place an order for LORRIC nozzles?

Example: 1/8 BSPT QFH 02 90 PVDF

1/8	BSPT	QFH	02	90	PVDF
↑	↑	↑	↑	↑	↑
Thread Type	Thread Size	Nozzle Series	Capacity Code	Spray Angle	Material

※ Standard Pressure: Column in red.
 ※ This product for spray angle 0°, 15° 25°, 40°, 50°, 100° and 110° is able to be made to order.

Spray Angle	Capacity Code	Capacity at Pressure									Average particle size (um)	Min. Free Passage (mm)	Filter mesh
		0.5 kgf/cm ²	1 kgf/cm ²	1.5 kgf/cm ²	2 kgf/cm ²	3 kgf/cm ²	4 kgf/cm ²	5 kgf/cm ²	6 kgf/cm ²	8 kgf/cm ²			
0°	2	0.32	0.45	0.55	0.64	0.78	0.90	1.01	1.11	1.28	-	-	-
	2.5	0.40	0.56	0.69	0.80	0.98	1.13	1.26	1.38	1.60	-	-	-
	3	0.48	0.68	0.83	0.96	1.17	1.35	1.51	1.66	1.92	-	-	-
	4	0.64	0.90	1.11	1.28	1.56	1.81	2.02	2.21	2.55	-	-	-
	5	0.80	1.13	1.38	1.60	1.96	2.26	2.52	2.76	3.19	-	-	-
	6	0.96	1.35	1.66	1.92	2.35	2.71	3.03	3.32	3.83	-	-	-
	7	1.12	1.58	1.94	2.23	2.74	3.16	3.53	3.87	4.47	-	-	-
	7.5	1.20	1.69	2.07	2.39	2.93	3.39	3.79	4.15	4.79	-	-	-
	8	1.28	1.81	2.21	2.55	3.13	3.61	4.04	4.42	5.11	-	-	-
	9	1.44	2.03	2.49	2.87	3.52	4.06	4.54	4.98	5.75	-	-	-
	10	1.60	2.26	2.76	3.19	3.91	4.51	5.05	5.53	6.39	-	-	-
	12.5	2.00	2.82	3.46	3.99	4.89	5.64	6.31	6.91	7.98	-	-	-
	15	2.39	3.39	4.15	4.79	5.87	6.77	7.57	8.29	9.58	-	-	-
	20	3.19	4.51	5.53	6.39	7.82	9.03	10.10	11.06	12.77	-	-	-
	25	3.99	5.64	6.91	7.98	9.78	11.29	12.62	13.82	15.96	-	-	-
30	4.79	6.77	8.29	9.58	11.73	13.54	15.14	16.59	19.16	-	-	-	

※ For MPa / bar / psi units, please refer to LORRIC.com.

Spray Angle	Capacity Code	Capacity at Pressure									Average particle size (um)	Min. Free Passage (mm)	Filter mesh
		0.5 kgf/cm ²	1 kgf/cm ²	1.5 kgf/cm ²	2 kgf/cm ²	3 kgf/cm ²	4 kgf/cm ²	5 kgf/cm ²	6 kgf/cm ²	8 kgf/cm ²			
15°	2	0.32	0.45	0.55	0.64	0.78	0.90	1.01	1.11	1.28	-	-	-
	2.5	0.40	0.56	0.69	0.80	0.98	1.13	1.26	1.38	1.60	-	-	-
	3	0.48	0.68	0.83	0.96	1.17	1.35	1.51	1.66	1.92	-	-	-
	4	0.64	0.90	1.11	1.28	1.56	1.81	2.02	2.21	2.55	-	-	-
	5	0.80	1.13	1.38	1.60	1.96	2.26	2.52	2.76	3.19	-	-	-
	6	0.96	1.35	1.66	1.92	2.35	2.71	3.03	3.32	3.83	-	-	-
	7	1.12	1.58	1.94	2.23	2.74	3.16	3.53	3.87	4.47	-	-	-
	7.5	1.20	1.69	2.07	2.39	2.93	3.39	3.79	4.15	4.79	-	-	-
	8	1.28	1.81	2.21	2.55	3.13	3.61	4.04	4.42	5.11	-	-	-
	9	1.44	2.03	2.49	2.87	3.52	4.06	4.54	4.98	5.75	-	-	-
	10	1.60	2.26	2.76	3.19	3.91	4.51	5.05	5.53	6.39	-	-	-
	12.5	2.00	2.82	3.46	3.99	4.89	5.64	6.31	6.91	7.98	-	-	-
	15	2.39	3.39	4.15	4.79	5.87	6.77	7.57	8.29	9.58	-	-	-
	20	3.19	4.51	5.53	6.39	7.82	9.03	10.10	11.06	12.77	-	-	-
	25	3.99	5.64	6.91	7.98	9.78	11.29	12.62	13.82	15.96	-	-	-
30	4.79	6.77	8.29	9.58	11.73	13.54	15.14	16.59	19.16	-	-	-	
25°	2	0.32	0.45	0.55	0.64	0.78	0.90	1.01	1.11	1.28	-	-	-
	2.5	0.40	0.56	0.69	0.80	0.98	1.13	1.26	1.38	1.60	-	-	-
	3	0.48	0.68	0.83	0.96	1.17	1.35	1.51	1.66	1.92	-	-	-
	4	0.64	0.90	1.11	1.28	1.56	1.81	2.02	2.21	2.55	-	-	-
	5	0.80	1.13	1.38	1.60	1.96	2.26	2.52	2.76	3.19	-	-	-
	6	0.96	1.35	1.66	1.92	2.35	2.71	3.03	3.32	3.83	-	-	-
	7	1.12	1.58	1.94	2.23	2.74	3.16	3.53	3.87	4.47	-	-	-
	7.5	1.20	1.69	2.07	2.39	2.93	3.39	3.79	4.15	4.79	-	-	-
	8	1.28	1.81	2.21	2.55	3.13	3.61	4.04	4.42	5.11	-	-	-
	9	1.44	2.03	2.49	2.87	3.52	4.06	4.54	4.98	5.75	-	-	-
	10	1.60	2.26	2.76	3.19	3.91	4.51	5.05	5.53	6.39	-	-	-
	12.5	2.00	2.82	3.46	3.99	4.89	5.64	6.31	6.91	7.98	-	-	-
	15	2.39	3.39	4.15	4.79	5.87	6.77	7.57	8.29	9.58	-	-	-
	20	3.19	4.51	5.53	6.39	7.82	9.03	10.10	11.06	12.77	-	-	-
	25	3.99	5.64	6.91	7.98	9.78	11.29	12.62	13.82	15.96	-	-	-
30	4.79	6.77	8.29	9.58	11.73	13.54	15.14	16.59	19.16	-	-	-	
40°	2	0.32	0.45	0.55	0.64	0.78	0.90	1.01	1.11	1.28	-	-	-
	2.5	0.40	0.56	0.69	0.80	0.98	1.13	1.26	1.38	1.60	-	-	-
	3	0.48	0.68	0.83	0.96	1.17	1.35	1.51	1.66	1.92	-	-	-
	4	0.64	0.90	1.11	1.28	1.56	1.81	2.02	2.21	2.55	-	-	-
	5	0.80	1.13	1.38	1.60	1.96	2.26	2.52	2.76	3.19	-	-	-
	6	0.96	1.35	1.66	1.92	2.35	2.71	3.03	3.32	3.83	-	-	-
	7	1.12	1.58	1.94	2.23	2.74	3.16	3.53	3.87	4.47	-	-	-
	7.5	1.20	1.69	2.07	2.39	2.93	3.39	3.79	4.15	4.79	-	-	-
	8	1.28	1.81	2.21	2.55	3.13	3.61	4.04	4.42	5.11	-	-	-
	9	1.44	2.03	2.49	2.87	3.52	4.06	4.54	4.98	5.75	-	-	-
	10	1.60	2.26	2.76	3.19	3.91	4.51	5.05	5.53	6.39	-	-	-
	12.5	2.00	2.82	3.46	3.99	4.89	5.64	6.31	6.91	7.98	-	-	-
	15	2.39	3.39	4.15	4.79	5.87	6.77	7.57	8.29	9.58	-	-	-
	20	3.19	4.51	5.53	6.39	7.82	9.03	10.10	11.06	12.77	-	-	-
	25	3.99	5.64	6.91	7.98	9.78	11.29	12.62	13.82	15.96	-	-	-
30	4.79	6.77	8.29	9.58	11.73	13.54	15.14	16.59	19.16	-	-	-	

※ For MPa / bar / psi units, please refer to LORRIC.com.

Spray Angle	Capacity Code	Capacity at Pressure									Average particle size (um)	Min. Free Passage (mm)	Filter mesh
		0.5 kgf/cm ²	1 kgf/cm ²	1.5 kgf/cm ²	2 kgf/cm ²	3 kgf/cm ²	4 kgf/cm ²	5 kgf/cm ²	6 kgf/cm ²	8 kgf/cm ²			
50°	2	0.32	0.45	0.55	0.64	0.78	0.90	1.01	1.11	1.28	-	-	-
	2.5	0.40	0.56	0.69	0.80	0.98	1.13	1.26	1.38	1.60	-	-	-
	3	0.48	0.68	0.83	0.96	1.17	1.35	1.51	1.66	1.92	-	-	-
	4	0.64	0.90	1.11	1.28	1.56	1.81	2.02	2.21	2.55	-	-	-
	5	0.80	1.13	1.38	1.60	1.96	2.26	2.52	2.76	3.19	-	-	-
	6	0.96	1.35	1.66	1.92	2.35	2.71	3.03	3.32	3.83	-	-	-
	7	1.12	1.58	1.94	2.23	2.74	3.16	3.53	3.87	4.47	-	-	-
	7.5	1.20	1.69	2.07	2.39	2.93	3.39	3.79	4.15	4.79	-	-	-
	8	1.28	1.81	2.21	2.55	3.13	3.61	4.04	4.42	5.11	-	-	-
	9	1.44	2.03	2.49	2.87	3.52	4.06	4.54	4.98	5.75	-	-	-
	10	1.60	2.26	2.76	3.19	3.91	4.51	5.05	5.53	6.39	-	-	-
	12.5	2.00	2.82	3.46	3.99	4.89	5.64	6.31	6.91	7.98	-	-	-
	15	2.39	3.39	4.15	4.79	5.87	6.77	7.57	8.29	9.58	-	-	-
	20	3.19	4.51	5.53	6.39	7.82	9.03	10.10	11.06	12.77	-	-	-
	25	3.99	5.64	6.91	7.98	9.78	11.29	12.62	13.82	15.96	-	-	-
30	4.79	6.77	8.29	9.58	11.73	13.54	15.14	16.59	19.16	-	-	-	
65°	2	0.32	0.45	0.55	0.64	0.78	0.90	1.01	1.11	1.28	-	0.4	150
	2.5	0.40	0.56	0.69	0.80	0.98	1.13	1.26	1.38	1.60	-	0.6	100
	3	0.48	0.68	0.83	0.96	1.17	1.35	1.51	1.66	1.92	-	0.7	100
	4	0.64	0.90	1.11	1.28	1.56	1.81	2.02	2.21	2.55	-	0.8	50
	5	0.80	1.13	1.38	1.60	1.96	2.26	2.52	2.76	3.19	-	0.9	50
	6	0.96	1.35	1.66	1.92	2.35	2.71	3.03	3.32	3.83	230	0.9	50
	7	1.12	1.58	1.94	2.23	2.74	3.16	3.53	3.87	4.47	-	1.0	-
	7.5	1.20	1.69	2.07	2.39	2.93	3.39	3.79	4.15	4.79	-	1.0	-
	8	1.28	1.81	2.21	2.55	3.13	3.61	4.04	4.42	5.11	-	1.1	-
	9	1.44	2.03	2.49	2.87	3.52	4.06	4.54	4.98	5.75	-	1.1	-
	10	1.60	2.26	2.76	3.19	3.91	4.51	5.05	5.53	6.39	-	1.2	-
	12.5	2.00	2.82	3.46	3.99	4.89	5.64	6.31	6.91	7.98	-	1.3	-
	15	2.39	3.39	4.15	4.79	5.87	6.77	7.57	8.29	9.58	-	1.4	-
	20	3.19	4.51	5.53	6.39	7.82	9.03	10.10	11.06	12.77	370	1.6	-
	25	3.99	5.64	6.91	7.98	9.78	11.29	12.62	13.82	15.96	-	2.0	-
30	4.79	6.77	8.29	9.58	11.73	13.54	15.14	16.59	19.16	-	2.3	-	
80°	2	0.32	0.45	0.55	0.64	0.78	0.90	1.01	1.11	1.28	-	0.3	150
	2.5	0.40	0.56	0.69	0.80	0.98	1.13	1.26	1.38	1.60	-	0.4	150
	3	0.48	0.68	0.83	0.96	1.17	1.35	1.51	1.66	1.92	-	0.4	150
	4	0.64	0.90	1.11	1.28	1.56	1.81	2.02	2.21	2.55	-	0.6	100
	5	0.80	1.13	1.38	1.60	1.96	2.26	2.52	2.76	3.19	220	0.7	50
	6	0.96	1.35	1.66	1.92	2.35	2.71	3.03	3.32	3.83	-	0.7	50
	7	1.12	1.58	1.94	2.23	2.74	3.16	3.53	3.87	4.47	-	0.9	50
	7.5	1.20	1.69	2.07	2.39	2.93	3.39	3.79	4.15	4.79	-	0.9	50
	8	1.28	1.81	2.21	2.55	3.13	3.61	4.04	4.42	5.11	-	1.0	-
	9	1.44	2.03	2.49	2.87	3.52	4.06	4.54	4.98	5.75	-	1.0	-
	10	1.60	2.26	2.76	3.19	3.91	4.51	5.05	5.53	6.39	-	1.1	-
	12.5	2.00	2.82	3.46	3.99	4.89	5.64	6.31	6.91	7.98	-	1.3	-
	15	2.39	3.39	4.15	4.79	5.87	6.77	7.57	8.29	9.58	-	1.4	-
	20	3.19	4.51	5.53	6.39	7.82	9.03	10.10	11.06	12.77	340	1.6	-
	25	3.99	5.64	6.91	7.98	9.78	11.29	12.62	13.82	15.96	-	1.9	-
30	4.79	6.77	8.29	9.58	11.73	13.54	15.14	16.59	19.16	-	2.1	-	

※ For MPa / bar / psi units, please refer to LORRIC.com.

Spray Angle	Capacity Code	Capacity at Pressure									Average particle size (um)	Min. Free Passage (mm)	Filter mesh
		0.5 kgf/cm ²	1 kgf/cm ²	1.5 kgf/cm ²	2 kgf/cm ²	3 kgf/cm ²	4 kgf/cm ²	5 kgf/cm ²	6 kgf/cm ²	8 kgf/cm ²			
90°	2	0.32	0.45	0.55	0.64	0.78	0.90	1.01	1.11	1.28	-	0.3	150
	2.5	0.40	0.56	0.69	0.80	0.98	1.13	1.26	1.38	1.60	-	0.4	150
	3	0.48	0.68	0.83	0.96	1.17	1.35	1.51	1.66	1.92	-	0.4	150
	4	0.64	0.90	1.11	1.28	1.56	1.81	2.02	2.21	2.55	-	0.5	100
	5	0.80	1.13	1.38	1.60	1.96	2.26	2.52	2.76	3.19	-	0.5	100
	6	0.96	1.35	1.66	1.92	2.35	2.71	3.03	3.32	3.83	210	0.5	100
	7	1.12	1.58	1.94	2.23	2.74	3.16	3.53	3.87	4.47	-	0.6	100
	7.5	1.20	1.69	2.07	2.39	2.93	3.39	3.79	4.15	4.79	-	0.8	50
	8	1.28	1.81	2.21	2.55	3.13	3.61	4.04	4.42	5.11	330	0.8	50
	9	1.44	2.03	2.49	2.87	3.52	4.06	4.54	4.98	5.75	-	0.8	50
	10	1.60	2.26	2.76	3.19	3.91	4.51	5.05	5.53	6.39	-	1.0	-
	12.5	2.00	2.82	3.46	3.99	4.89	5.64	6.31	6.91	7.98	-	1.1	-
	15	2.39	3.39	4.15	4.79	5.87	6.77	7.57	8.29	9.58	-	1.2	-
	20	3.19	4.51	5.53	6.39	7.82	9.03	10.10	11.06	12.77	-	1.4	-
	25	3.99	5.64	6.91	7.98	9.78	11.29	12.62	13.82	15.96	-	1.6	-
30	4.79	6.77	8.29	9.58	11.73	13.54	15.14	16.59	19.16	-	1.8	-	
100°	2	0.32	0.45	0.55	0.64	0.78	0.90	1.01	1.11	1.28	-	-	-
	2.5	0.40	0.56	0.69	0.80	0.98	1.13	1.26	1.38	1.60	-	-	-
	3	0.48	0.68	0.83	0.96	1.17	1.35	1.51	1.66	1.92	-	-	-
	4	0.64	0.90	1.11	1.28	1.56	1.81	2.02	2.21	2.55	-	-	-
	5	0.80	1.13	1.38	1.60	1.96	2.26	2.52	2.76	3.19	-	-	-
	6	0.96	1.35	1.66	1.92	2.35	2.71	3.03	3.32	3.83	-	-	-
	7	1.12	1.58	1.94	2.23	2.74	3.16	3.53	3.87	4.47	-	-	-
	7.5	1.20	1.69	2.07	2.39	2.93	3.39	3.79	4.15	4.79	-	-	-
	8	1.28	1.81	2.21	2.55	3.13	3.61	4.04	4.42	5.11	-	-	-
	9	1.44	2.03	2.49	2.87	3.52	4.06	4.54	4.98	5.75	-	-	-
	10	1.60	2.26	2.76	3.19	3.91	4.51	5.05	5.53	6.39	-	-	-
	12.5	2.00	2.82	3.46	3.99	4.89	5.64	6.31	6.91	7.98	-	-	-
	15	2.39	3.39	4.15	4.79	5.87	6.77	7.57	8.29	9.58	-	-	-
	20	3.19	4.51	5.53	6.39	7.82	9.03	10.10	11.06	12.77	-	-	-
	25	3.99	5.64	6.91	7.98	9.78	11.29	12.62	13.82	15.96	-	-	-
30	4.79	6.77	8.29	9.58	11.73	13.54	15.14	16.59	19.16	-	-	-	
110°	2	0.32	0.45	0.55	0.64	0.78	0.90	1.01	1.11	1.28	-	-	-
	2.5	0.40	0.56	0.69	0.80	0.98	1.13	1.26	1.38	1.60	-	-	-
	3	0.48	0.68	0.83	0.96	1.17	1.35	1.51	1.66	1.92	-	-	-
	4	0.64	0.90	1.11	1.28	1.56	1.81	2.02	2.21	2.55	-	-	-
	5	0.80	1.13	1.38	1.60	1.96	2.26	2.52	2.76	3.19	-	-	-
	6	0.96	1.35	1.66	1.92	2.35	2.71	3.03	3.32	3.83	-	-	-
	7	1.12	1.58	1.94	2.23	2.74	3.16	3.53	3.87	4.47	-	-	-
	7.5	1.20	1.69	2.07	2.39	2.93	3.39	3.79	4.15	4.79	-	-	-
	8	1.28	1.81	2.21	2.55	3.13	3.61	4.04	4.42	5.11	-	-	-
	9	1.44	2.03	2.49	2.87	3.52	4.06	4.54	4.98	5.75	-	-	-
	10	1.60	2.26	2.76	3.19	3.91	4.51	5.05	5.53	6.39	-	-	-
	12.5	2.00	2.82	3.46	3.99	4.89	5.64	6.31	6.91	7.98	-	-	-
	15	2.39	3.39	4.15	4.79	5.87	6.77	7.57	8.29	9.58	-	-	-
	20	3.19	4.51	5.53	6.39	7.82	9.03	10.10	11.06	12.77	-	-	-
	25	3.99	5.64	6.91	7.98	9.78	11.29	12.62	13.82	15.96	-	-	-
30	4.79	6.77	8.29	9.58	11.73	13.54	15.14	16.59	19.16	-	-	-	

※ For MPa / bar / psi units, please refer to LORRIC.com.

QFYH High chemical resistance plastic easy install flat fan nozzle



【 Top view of nozzle spray pattern 】



【 Flow distribution 】

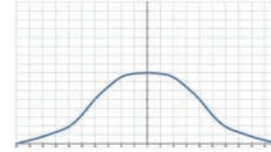

- Recommended working pressure: 3.0 kgf/cm²
- Flowrate tolerance: ± 5% @ 3.0 ± 0.1kgf/cm²
- Angle tolerance: ± 5° @ 3.0 ± 0.1kgf/cm²
- Jet angle tolerance: 3°

Features

- The spraying type is fan type, and the spray shape is single line and two sides are tapered (tapered edge), which presents a bell curve shape flow field distribution with weaker ends compared to the middle. Products with special flow field distribution can be customized.
- Two piece nozzle design which includes nozzle and the body allows quick and accurate installation by hand. It is convenient for on-site management. Nozzle tip is secured into the body and fastened by three buckle points to avoid the nozzle tip loosening and ensure the performance quality.

- The internal gaskets are available in various options such as EPDM, Viton and Viton-F, which can be adapted to various chemical processes. The special structural design allows the nozzles and the base to fit closely and avoid water leakage.

- Y-shaped rotary handle design leads to easier dismantling.
- PVDF is resistant to temperature and corrosive chemical solutions.

Applications

- Cleaning: Vehicles, Containers, Filters, Dust, Gravel, Metals, Metal Parts, Machinery, Steel Plates, Various Containers, etc.
- Cooling: Tank, Machinery, Metal, Roof etc.
- Dispersion: Humidifying, chemicals (eg. etching solution, developer, insect repellent, etc.), firefighting, dedust, deodorization, etc.

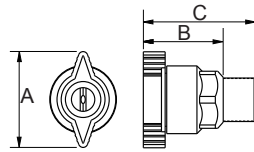

Appearance dimensions may vary depending on model, material. Please ask for details.

Material	Serie	Unit (mm)			Thread Type	Weight (g)	
		A	B	C		PP	PVDF
Plastic	1/8QFYH	36	28	39	1/8M	9.9	17.7
	1/4QFYH	36	28	43	1/4M	10.1	18.1
	3/8QFYH	36	28	43	3/8M	11.1	19.8

Material

- TIP: PP, PVDF
- Oring: EPDM, VITON
- Base: PP, PVDF, U-PVC (QFSA, QFWG)

How to place an order for LORRIC nozzles?

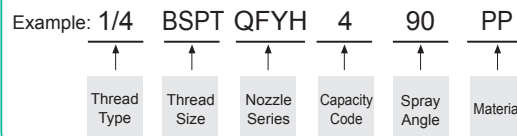

※ Standard Pressure: Column in red.
 ※ This product for spray angle 0°, 15° 25°, 40°, 50°, 100° and 110° is able to be made to order.

Spray Angle	Capacity Code	Capacity at Pressure									Average particle size (um)	Min. Free Passage (mm)	Filter mesh
		0.5 kgf/cm ²	1 kgf/cm ²	1.5 kgf/cm ²	2 kgf/cm ²	3 kgf/cm ²	4 kgf/cm ²	5 kgf/cm ²	6 kgf/cm ²	8 kgf/cm ²			
0°	2	0.32	0.45	0.55	0.64	0.78	0.90	1.01	1.11	1.28	-	-	-
	2.5	0.40	0.56	0.69	0.80	0.98	1.13	1.26	1.38	1.60	-	-	-
	3	0.48	0.68	0.83	0.96	1.17	1.35	1.51	1.66	1.92	-	-	-
	4	0.64	0.90	1.11	1.28	1.56	1.81	2.02	2.21	2.55	-	-	-
	5	0.80	1.13	1.38	1.60	1.96	2.26	2.52	2.76	3.19	-	-	-
	6	0.96	1.35	1.66	1.92	2.35	2.71	3.03	3.32	3.83	-	-	-
	7	1.12	1.58	1.94	2.23	2.74	3.16	3.53	3.87	4.47	-	-	-
	7.5	1.20	1.69	2.07	2.39	2.93	3.39	3.79	4.15	4.79	-	-	-
	8	1.28	1.81	2.21	2.55	3.13	3.61	4.04	4.42	5.11	-	-	-
	9	1.44	2.03	2.49	2.87	3.52	4.06	4.54	4.98	5.75	-	-	-
	10	1.60	2.26	2.76	3.19	3.91	4.51	5.05	5.53	6.39	-	-	-
	12.5	2.00	2.82	3.46	3.99	4.89	5.64	6.31	6.91	7.98	-	-	-
	15	2.39	3.39	4.15	4.79	5.87	6.77	7.57	8.29	9.58	-	-	-
	20	3.19	4.51	5.53	6.39	7.82	9.03	10.10	11.06	12.77	-	-	-
	25	3.99	5.64	6.91	7.98	9.78	11.29	12.62	13.82	15.96	-	-	-
30	4.79	6.77	8.29	9.58	11.73	13.54	15.14	16.59	19.16	-	-	-	

※ For MPa / bar / psi units, please refer to LORRIC.com.

Spray Angle	Capacity Code	Capacity at Pressure									Average particle size (um)	Min. Free Passage (mm)	Filter mesh
		0.5 kgf/cm ²	1 kgf/cm ²	1.5 kgf/cm ²	2 kgf/cm ²	3 kgf/cm ²	4 kgf/cm ²	5 kgf/cm ²	6 kgf/cm ²	8 kgf/cm ²			
15°	2	0.32	0.45	0.55	0.64	0.78	0.90	1.01	1.11	1.28	-	-	-
	2.5	0.40	0.56	0.69	0.80	0.98	1.13	1.26	1.38	1.60	-	-	-
	3	0.48	0.68	0.83	0.96	1.17	1.35	1.51	1.66	1.92	-	-	-
	4	0.64	0.90	1.11	1.28	1.56	1.81	2.02	2.21	2.55	-	-	-
	5	0.80	1.13	1.38	1.60	1.96	2.26	2.52	2.76	3.19	-	-	-
	6	0.96	1.35	1.66	1.92	2.35	2.71	3.03	3.32	3.83	-	-	-
	7	1.12	1.58	1.94	2.23	2.74	3.16	3.53	3.87	4.47	-	-	-
	7.5	1.20	1.69	2.07	2.39	2.93	3.39	3.79	4.15	4.79	-	-	-
	8	1.28	1.81	2.21	2.55	3.13	3.61	4.04	4.42	5.11	-	-	-
	9	1.44	2.03	2.49	2.87	3.52	4.06	4.54	4.98	5.75	-	-	-
	10	1.60	2.26	2.76	3.19	3.91	4.51	5.05	5.53	6.39	-	-	-
	12.5	2.00	2.82	3.46	3.99	4.89	5.64	6.31	6.91	7.98	-	-	-
	15	2.39	3.39	4.15	4.79	5.87	6.77	7.57	8.29	9.58	-	-	-
	20	3.19	4.51	5.53	6.39	7.82	9.03	10.10	11.06	12.77	-	-	-
	25	3.99	5.64	6.91	7.98	9.78	11.29	12.62	13.82	15.96	-	-	-
30	4.79	6.77	8.29	9.58	11.73	13.54	15.14	16.59	19.16	-	-	-	
25°	2	0.32	0.45	0.55	0.64	0.78	0.90	1.01	1.11	1.28	-	-	-
	2.5	0.40	0.56	0.69	0.80	0.98	1.13	1.26	1.38	1.60	-	-	-
	3	0.48	0.68	0.83	0.96	1.17	1.35	1.51	1.66	1.92	-	-	-
	4	0.64	0.90	1.11	1.28	1.56	1.81	2.02	2.21	2.55	-	-	-
	5	0.80	1.13	1.38	1.60	1.96	2.26	2.52	2.76	3.19	-	-	-
	6	0.96	1.35	1.66	1.92	2.35	2.71	3.03	3.32	3.83	-	-	-
	7	1.12	1.58	1.94	2.23	2.74	3.16	3.53	3.87	4.47	-	-	-
	7.5	1.20	1.69	2.07	2.39	2.93	3.39	3.79	4.15	4.79	-	-	-
	8	1.28	1.81	2.21	2.55	3.13	3.61	4.04	4.42	5.11	-	-	-
	9	1.44	2.03	2.49	2.87	3.52	4.06	4.54	4.98	5.75	-	-	-
	10	1.60	2.26	2.76	3.19	3.91	4.51	5.05	5.53	6.39	-	-	-
	12.5	2.00	2.82	3.46	3.99	4.89	5.64	6.31	6.91	7.98	-	-	-
	15	2.39	3.39	4.15	4.79	5.87	6.77	7.57	8.29	9.58	-	-	-
	20	3.19	4.51	5.53	6.39	7.82	9.03	10.10	11.06	12.77	-	-	-
	25	3.99	5.64	6.91	7.98	9.78	11.29	12.62	13.82	15.96	-	-	-
30	4.79	6.77	8.29	9.58	11.73	13.54	15.14	16.59	19.16	-	-	-	
40°	2	0.32	0.45	0.55	0.64	0.78	0.90	1.01	1.11	1.28	-	-	-
	2.5	0.40	0.56	0.69	0.80	0.98	1.13	1.26	1.38	1.60	-	-	-
	3	0.48	0.68	0.83	0.96	1.17	1.35	1.51	1.66	1.92	-	-	-
	4	0.64	0.90	1.11	1.28	1.56	1.81	2.02	2.21	2.55	-	-	-
	5	0.80	1.13	1.38	1.60	1.96	2.26	2.52	2.76	3.19	-	-	-
	6	0.96	1.35	1.66	1.92	2.35	2.71	3.03	3.32	3.83	-	-	-
	7	1.12	1.58	1.94	2.23	2.74	3.16	3.53	3.87	4.47	-	-	-
	7.5	1.20	1.69	2.07	2.39	2.93	3.39	3.79	4.15	4.79	-	-	-
	8	1.28	1.81	2.21	2.55	3.13	3.61	4.04	4.42	5.11	-	-	-
	9	1.44	2.03	2.49	2.87	3.52	4.06	4.54	4.98	5.75	-	-	-
	10	1.60	2.26	2.76	3.19	3.91	4.51	5.05	5.53	6.39	-	-	-
	12.5	2.00	2.82	3.46	3.99	4.89	5.64	6.31	6.91	7.98	-	-	-
	15	2.39	3.39	4.15	4.79	5.87	6.77	7.57	8.29	9.58	-	-	-
	20	3.19	4.51	5.53	6.39	7.82	9.03	10.10	11.06	12.77	-	-	-
	25	3.99	5.64	6.91	7.98	9.78	11.29	12.62	13.82	15.96	-	-	-
30	4.79	6.77	8.29	9.58	11.73	13.54	15.14	16.59	19.16	-	-	-	

※ For MPa / bar / psi units, please refer to LORRIC.com.

Spray Angle	Capacity Code	Capacity at Pressure									Average particle size (um)	Min. Free Passage (mm)	Filter mesh
		0.5 kgf/cm ²	1 kgf/cm ²	1.5 kgf/cm ²	2 kgf/cm ²	3 kgf/cm ²	4 kgf/cm ²	5 kgf/cm ²	6 kgf/cm ²	8 kgf/cm ²			
50°	2	0.32	0.45	0.55	0.64	0.78	0.90	1.01	1.11	1.28	-	-	-
	2.5	0.40	0.56	0.69	0.80	0.98	1.13	1.26	1.38	1.60	-	-	-
	3	0.48	0.68	0.83	0.96	1.17	1.35	1.51	1.66	1.92	-	-	-
	4	0.64	0.90	1.11	1.28	1.56	1.81	2.02	2.21	2.55	-	-	-
	5	0.80	1.13	1.38	1.60	1.96	2.26	2.52	2.76	3.19	-	-	-
	6	0.96	1.35	1.66	1.92	2.35	2.71	3.03	3.32	3.83	-	-	-
	7	1.12	1.58	1.94	2.23	2.74	3.16	3.53	3.87	4.47	-	-	-
	7.5	1.20	1.69	2.07	2.39	2.93	3.39	3.79	4.15	4.79	-	-	-
	8	1.28	1.81	2.21	2.55	3.13	3.61	4.04	4.42	5.11	-	-	-
	9	1.44	2.03	2.49	2.87	3.52	4.06	4.54	4.98	5.75	-	-	-
	10	1.60	2.26	2.76	3.19	3.91	4.51	5.05	5.53	6.39	-	-	-
	12.5	2.00	2.82	3.46	3.99	4.89	5.64	6.31	6.91	7.98	-	-	-
	15	2.39	3.39	4.15	4.79	5.87	6.77	7.57	8.29	9.58	-	-	-
	20	3.19	4.51	5.53	6.39	7.82	9.03	10.10	11.06	12.77	-	-	-
	25	3.99	5.64	6.91	7.98	9.78	11.29	12.62	13.82	15.96	-	-	-
30	4.79	6.77	8.29	9.58	11.73	13.54	15.14	16.59	19.16	-	-	-	
65°	2	0.32	0.45	0.55	0.64	0.78	0.90	1.01	1.11	1.28	-	0.4	150
	2.5	0.40	0.56	0.69	0.80	0.98	1.13	1.26	1.38	1.60	-	0.6	100
	3	0.48	0.68	0.83	0.96	1.17	1.35	1.51	1.66	1.92	-	0.7	100
	4	0.64	0.90	1.11	1.28	1.56	1.81	2.02	2.21	2.55	-	0.8	50
	5	0.80	1.13	1.38	1.60	1.96	2.26	2.52	2.76	3.19	-	0.9	50
	6	0.96	1.35	1.66	1.92	2.35	2.71	3.03	3.32	3.83	230	0.9	50
	7	1.12	1.58	1.94	2.23	2.74	3.16	3.53	3.87	4.47	-	1.0	-
	7.5	1.20	1.69	2.07	2.39	2.93	3.39	3.79	4.15	4.79	-	1.0	-
	8	1.28	1.81	2.21	2.55	3.13	3.61	4.04	4.42	5.11	-	1.1	-
	9	1.44	2.03	2.49	2.87	3.52	4.06	4.54	4.98	5.75	-	1.1	-
	10	1.60	2.26	2.76	3.19	3.91	4.51	5.05	5.53	6.39	-	1.2	-
	12.5	2.00	2.82	3.46	3.99	4.89	5.64	6.31	6.91	7.98	-	1.3	-
	15	2.39	3.39	4.15	4.79	5.87	6.77	7.57	8.29	9.58	-	1.4	-
	20	3.19	4.51	5.53	6.39	7.82	9.03	10.10	11.06	12.77	370	1.6	-
	25	3.99	5.64	6.91	7.98	9.78	11.29	12.62	13.82	15.96	-	2.0	-
30	4.79	6.77	8.29	9.58	11.73	13.54	15.14	16.59	19.16	-	2.3	-	
80°	2	0.32	0.45	0.55	0.64	0.78	0.90	1.01	1.11	1.28	-	0.3	150
	2.5	0.40	0.56	0.69	0.80	0.98	1.13	1.26	1.38	1.60	-	0.4	150
	3	0.48	0.68	0.83	0.96	1.17	1.35	1.51	1.66	1.92	-	0.4	150
	4	0.64	0.90	1.11	1.28	1.56	1.81	2.02	2.21	2.55	-	0.6	100
	5	0.80	1.13	1.38	1.60	1.96	2.26	2.52	2.76	3.19	220	0.7	50
	6	0.96	1.35	1.66	1.92	2.35	2.71	3.03	3.32	3.83	-	0.7	50
	7	1.12	1.58	1.94	2.23	2.74	3.16	3.53	3.87	4.47	-	0.9	50
	7.5	1.20	1.69	2.07	2.39	2.93	3.39	3.79	4.15	4.79	-	0.9	50
	8	1.28	1.81	2.21	2.55	3.13	3.61	4.04	4.42	5.11	-	1.0	-
	9	1.44	2.03	2.49	2.87	3.52	4.06	4.54	4.98	5.75	-	1.0	-
	10	1.60	2.26	2.76	3.19	3.91	4.51	5.05	5.53	6.39	-	1.1	-
	12.5	2.00	2.82	3.46	3.99	4.89	5.64	6.31	6.91	7.98	-	1.3	-
	15	2.39	3.39	4.15	4.79	5.87	6.77	7.57	8.29	9.58	-	1.4	-
	20	3.19	4.51	5.53	6.39	7.82	9.03	10.10	11.06	12.77	340	1.6	-
	25	3.99	5.64	6.91	7.98	9.78	11.29	12.62	13.82	15.96	-	1.9	-
30	4.79	6.77	8.29	9.58	11.73	13.54	15.14	16.59	19.16	-	2.1	-	

※ For MPa / bar / psi units, please refer to LORRIC.com.

Spray Angle	Capacity Code	Capacity at Pressure									Average particle size (um)	Min. Free Passage (mm)	Filter mesh
		0.5 kgf/cm ²	1 kgf/cm ²	1.5 kgf/cm ²	2 kgf/cm ²	3 kgf/cm ²	4 kgf/cm ²	5 kgf/cm ²	6 kgf/cm ²	8 kgf/cm ²			
90°	2	0.32	0.45	0.55	0.64	0.78	0.90	1.01	1.11	1.28	-	0.3	150
	2.5	0.40	0.56	0.69	0.80	0.98	1.13	1.26	1.38	1.60	-	0.4	150
	3	0.48	0.68	0.83	0.96	1.17	1.35	1.51	1.66	1.92	-	0.4	150
	4	0.64	0.90	1.11	1.28	1.56	1.81	2.02	2.21	2.55	-	0.5	100
	5	0.80	1.13	1.38	1.60	1.96	2.26	2.52	2.76	3.19	-	0.5	100
	6	0.96	1.35	1.66	1.92	2.35	2.71	3.03	3.32	3.83	210	0.5	100
	7	1.12	1.58	1.94	2.23	2.74	3.16	3.53	3.87	4.47	-	0.6	100
	7.5	1.20	1.69	2.07	2.39	2.93	3.39	3.79	4.15	4.79	-	0.8	50
	8	1.28	1.81	2.21	2.55	3.13	3.61	4.04	4.42	5.11	330	0.8	50
	9	1.44	2.03	2.49	2.87	3.52	4.06	4.54	4.98	5.75	-	0.8	50
	10	1.60	2.26	2.76	3.19	3.91	4.51	5.05	5.53	6.39	-	1.0	-
	12.5	2.00	2.82	3.46	3.99	4.89	5.64	6.31	6.91	7.98	-	1.1	-
	15	2.39	3.39	4.15	4.79	5.87	6.77	7.57	8.29	9.58	-	1.2	-
	20	3.19	4.51	5.53	6.39	7.82	9.03	10.10	11.06	12.77	-	1.4	-
	25	3.99	5.64	6.91	7.98	9.78	11.29	12.62	13.82	15.96	-	1.6	-
30	4.79	6.77	8.29	9.58	11.73	13.54	15.14	16.59	19.16	-	1.8	-	
100°	2	0.32	0.45	0.55	0.64	0.78	0.90	1.01	1.11	1.28	-	-	-
	2.5	0.40	0.56	0.69	0.80	0.98	1.13	1.26	1.38	1.60	-	-	-
	3	0.48	0.68	0.83	0.96	1.17	1.35	1.51	1.66	1.92	-	-	-
	4	0.64	0.90	1.11	1.28	1.56	1.81	2.02	2.21	2.55	-	-	-
	5	0.80	1.13	1.38	1.60	1.96	2.26	2.52	2.76	3.19	-	-	-
	6	0.96	1.35	1.66	1.92	2.35	2.71	3.03	3.32	3.83	-	-	-
	7	1.12	1.58	1.94	2.23	2.74	3.16	3.53	3.87	4.47	-	-	-
	7.5	1.20	1.69	2.07	2.39	2.93	3.39	3.79	4.15	4.79	-	-	-
	8	1.28	1.81	2.21	2.55	3.13	3.61	4.04	4.42	5.11	-	-	-
	9	1.44	2.03	2.49	2.87	3.52	4.06	4.54	4.98	5.75	-	-	-
	10	1.60	2.26	2.76	3.19	3.91	4.51	5.05	5.53	6.39	-	-	-
	12.5	2.00	2.82	3.46	3.99	4.89	5.64	6.31	6.91	7.98	-	-	-
	15	2.39	3.39	4.15	4.79	5.87	6.77	7.57	8.29	9.58	-	-	-
	20	3.19	4.51	5.53	6.39	7.82	9.03	10.10	11.06	12.77	-	-	-
	25	3.99	5.64	6.91	7.98	9.78	11.29	12.62	13.82	15.96	-	-	-
30	4.79	6.77	8.29	9.58	11.73	13.54	15.14	16.59	19.16	-	-	-	
110°	2	0.32	0.45	0.55	0.64	0.78	0.90	1.01	1.11	1.28	-	-	-
	2.5	0.40	0.56	0.69	0.80	0.98	1.13	1.26	1.38	1.60	-	-	-
	3	0.48	0.68	0.83	0.96	1.17	1.35	1.51	1.66	1.92	-	-	-
	4	0.64	0.90	1.11	1.28	1.56	1.81	2.02	2.21	2.55	-	-	-
	5	0.80	1.13	1.38	1.60	1.96	2.26	2.52	2.76	3.19	-	-	-
	6	0.96	1.35	1.66	1.92	2.35	2.71	3.03	3.32	3.83	-	-	-
	7	1.12	1.58	1.94	2.23	2.74	3.16	3.53	3.87	4.47	-	-	-
	7.5	1.20	1.69	2.07	2.39	2.93	3.39	3.79	4.15	4.79	-	-	-
	8	1.28	1.81	2.21	2.55	3.13	3.61	4.04	4.42	5.11	-	-	-
	9	1.44	2.03	2.49	2.87	3.52	4.06	4.54	4.98	5.75	-	-	-
	10	1.60	2.26	2.76	3.19	3.91	4.51	5.05	5.53	6.39	-	-	-
	12.5	2.00	2.82	3.46	3.99	4.89	5.64	6.31	6.91	7.98	-	-	-
	15	2.39	3.39	4.15	4.79	5.87	6.77	7.57	8.29	9.58	-	-	-
	20	3.19	4.51	5.53	6.39	7.82	9.03	10.10	11.06	12.77	-	-	-
	25	3.99	5.64	6.91	7.98	9.78	11.29	12.62	13.82	15.96	-	-	-
30	4.79	6.77	8.29	9.58	11.73	13.54	15.14	16.59	19.16	-	-	-	

※ For MPa / bar / psi units, please refer to LORRIC.com.

QSH Plastic easy install flat fan nozzle

Flat Fan Nozzles



【 Top view of nozzle spray pattern 】



【 Flow distribution 】

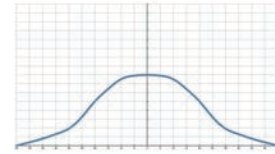

- Recommended working pressure: 3.0 kgf/cm²
- Flowrate tolerance: ± 10% @ 3.0 ± 0.1 kgf/cm²
- Angle tolerance: ± 10° @ 3.0 ± 0.1 kgf/cm²
- Jet angle tolerance: 3°

Features

- The spraying type is fan type, and the spray shape is single line and two sides are tapered (tapered edge), which presents a bell curve shape flow field distribution with weaker ends compared to the middle.
- Two piece nozzle design which includes nozzle and the body allows quick and accurate installation by hand. It is convenient for on-site management. Nozzle tip is secured into the body and fastened by three buckle points to avoid the nozzle tip loosening and ensure the performance quality.

- The internal gaskets have different options such as EPDM, Viton and Viton-F, which can be adapted to various chemical processes. With a special structural design, the nozzles and the base can be closely fitted to avoid water leakage.
- These general-purpose nozzles without guaranteed flow and angle tolerance are not recommended for environments with high accuracy requirements.

Applications

- Cleaning: Vehicles, containers, filters, dust, gravel, metals, metal parts, mechanical, steel plates, various containers, etc.
- Cooling: Gas, tank, machinery, metal, roof, etc.
- Dispersion: Humidifying, chemicals (etching solution, developer, insect repellent, etc.), Water Curtain (fire, dust, deodorisation, etc.)
- Printed circuit board: etching process, developing process, washing process.

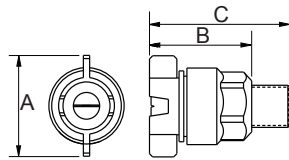

Appearance dimensions may vary depending on model, material. Please ask for details.

Material	Serie	Unit (mm)			Thread Type	Weight (g)
		A	B	C		
PP	1/4QSH	32	31	44	1/4M	7.9
	3/8QSH	32	31	44	3/8M	12.1

Material

- TIP: PP
- Oring: EPDM, VITON, VITON-F
- Base: PP, C-PVC

How to place an order for LORRIC nozzles?

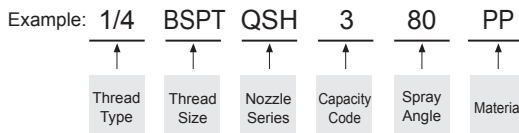

※ Standard Pressure: Column in red.
 ※ This product for spray angle 0°, 15° 25°, 40°, 50°, 100° and 110° is able to be made to order.

Spray Angle	Capacity Code	Capacity at Pressure									Average particle size (um)	Min. Free Passage (mm)	Filter mesh
		0.5 kgf/cm ²	1 kgf/cm ²	1.5 kgf/cm ²	2 kgf/cm ²	3 kgf/cm ²	4 kgf/cm ²	5 kgf/cm ²	6 kgf/cm ²	8 kgf/cm ²			
0°	2	0.32	0.45	0.55	0.64	0.78	0.90	1.01	1.11	1.28	-	-	-
	2.5	0.40	0.56	0.69	0.80	0.98	1.13	1.26	1.38	1.60	-	-	-
	3	0.48	0.68	0.83	0.96	1.17	1.35	1.51	1.66	1.92	-	-	-
	4	0.64	0.90	1.11	1.28	1.56	1.81	2.02	2.21	2.55	-	-	-
	5	0.80	1.13	1.38	1.60	1.96	2.26	2.52	2.76	3.19	-	-	-
	6	0.96	1.35	1.66	1.92	2.35	2.71	3.03	3.32	3.83	-	-	-
	7	1.12	1.58	1.94	2.23	2.74	3.16	3.53	3.87	4.47	-	-	-
	7.5	1.20	1.69	2.07	2.39	2.93	3.39	3.79	4.15	4.79	-	-	-
	8	1.28	1.81	2.21	2.55	3.13	3.61	4.04	4.42	5.11	-	-	-
	9	1.44	2.03	2.49	2.87	3.52	4.06	4.54	4.98	5.75	-	-	-
	10	1.60	2.26	2.76	3.19	3.91	4.51	5.05	5.53	6.39	-	-	-
	12.5	2.00	2.82	3.46	3.99	4.89	5.64	6.31	6.91	7.98	-	-	-
	15	2.39	3.39	4.15	4.79	5.87	6.77	7.57	8.29	9.58	-	-	-
	20	3.19	4.51	5.53	6.39	7.82	9.03	10.10	11.06	12.77	-	-	-
	25	3.99	5.64	6.91	7.98	9.78	11.29	12.62	13.82	15.96	-	-	-
30	4.79	6.77	8.29	9.58	11.73	13.54	15.14	16.59	19.16	-	-	-	

※ For MPa / bar / psi units, please refer to LORRIC.com.

Spray Angle	Capacity Code	Capacity at Pressure									Average particle size (um)	Min. Free Passage (mm)	Filter mesh
		0.5 kgf/cm ²	1 kgf/cm ²	1.5 kgf/cm ²	2 kgf/cm ²	3 kgf/cm ²	4 kgf/cm ²	5 kgf/cm ²	6 kgf/cm ²	8 kgf/cm ²			
15°	2	0.32	0.45	0.55	0.64	0.78	0.90	1.01	1.11	1.28	-	-	-
	2.5	0.40	0.56	0.69	0.80	0.98	1.13	1.26	1.38	1.60	-	-	-
	3	0.48	0.68	0.83	0.96	1.17	1.35	1.51	1.66	1.92	-	-	-
	4	0.64	0.90	1.11	1.28	1.56	1.81	2.02	2.21	2.55	-	-	-
	5	0.80	1.13	1.38	1.60	1.96	2.26	2.52	2.76	3.19	-	-	-
	6	0.96	1.35	1.66	1.92	2.35	2.71	3.03	3.32	3.83	-	-	-
	7	1.12	1.58	1.94	2.23	2.74	3.16	3.53	3.87	4.47	-	-	-
	7.5	1.20	1.69	2.07	2.39	2.93	3.39	3.79	4.15	4.79	-	-	-
	8	1.28	1.81	2.21	2.55	3.13	3.61	4.04	4.42	5.11	-	-	-
	9	1.44	2.03	2.49	2.87	3.52	4.06	4.54	4.98	5.75	-	-	-
	10	1.60	2.26	2.76	3.19	3.91	4.51	5.05	5.53	6.39	-	-	-
	12.5	2.00	2.82	3.46	3.99	4.89	5.64	6.31	6.91	7.98	-	-	-
	15	2.39	3.39	4.15	4.79	5.87	6.77	7.57	8.29	9.58	-	-	-
	20	3.19	4.51	5.53	6.39	7.82	9.03	10.10	11.06	12.77	-	-	-
	25	3.99	5.64	6.91	7.98	9.78	11.29	12.62	13.82	15.96	-	-	-
30	4.79	6.77	8.29	9.58	11.73	13.54	15.14	16.59	19.16	-	-	-	
25°	2	0.32	0.45	0.55	0.64	0.78	0.90	1.01	1.11	1.28	-	-	-
	2.5	0.40	0.56	0.69	0.80	0.98	1.13	1.26	1.38	1.60	-	-	-
	3	0.48	0.68	0.83	0.96	1.17	1.35	1.51	1.66	1.92	-	-	-
	4	0.64	0.90	1.11	1.28	1.56	1.81	2.02	2.21	2.55	-	-	-
	5	0.80	1.13	1.38	1.60	1.96	2.26	2.52	2.76	3.19	-	-	-
	6	0.96	1.35	1.66	1.92	2.35	2.71	3.03	3.32	3.83	-	-	-
	7	1.12	1.58	1.94	2.23	2.74	3.16	3.53	3.87	4.47	-	-	-
	7.5	1.20	1.69	2.07	2.39	2.93	3.39	3.79	4.15	4.79	-	-	-
	8	1.28	1.81	2.21	2.55	3.13	3.61	4.04	4.42	5.11	-	-	-
	9	1.44	2.03	2.49	2.87	3.52	4.06	4.54	4.98	5.75	-	-	-
	10	1.60	2.26	2.76	3.19	3.91	4.51	5.05	5.53	6.39	-	-	-
	12.5	2.00	2.82	3.46	3.99	4.89	5.64	6.31	6.91	7.98	-	-	-
	15	2.39	3.39	4.15	4.79	5.87	6.77	7.57	8.29	9.58	-	-	-
	20	3.19	4.51	5.53	6.39	7.82	9.03	10.10	11.06	12.77	-	-	-
	25	3.99	5.64	6.91	7.98	9.78	11.29	12.62	13.82	15.96	-	-	-
30	4.79	6.77	8.29	9.58	11.73	13.54	15.14	16.59	19.16	-	-	-	
40°	2	0.32	0.45	0.55	0.64	0.78	0.90	1.01	1.11	1.28	-	-	-
	2.5	0.40	0.56	0.69	0.80	0.98	1.13	1.26	1.38	1.60	-	-	-
	3	0.48	0.68	0.83	0.96	1.17	1.35	1.51	1.66	1.92	-	-	-
	4	0.64	0.90	1.11	1.28	1.56	1.81	2.02	2.21	2.55	-	-	-
	5	0.80	1.13	1.38	1.60	1.96	2.26	2.52	2.76	3.19	-	-	-
	6	0.96	1.35	1.66	1.92	2.35	2.71	3.03	3.32	3.83	-	-	-
	7	1.12	1.58	1.94	2.23	2.74	3.16	3.53	3.87	4.47	-	-	-
	7.5	1.20	1.69	2.07	2.39	2.93	3.39	3.79	4.15	4.79	-	-	-
	8	1.28	1.81	2.21	2.55	3.13	3.61	4.04	4.42	5.11	-	-	-
	9	1.44	2.03	2.49	2.87	3.52	4.06	4.54	4.98	5.75	-	-	-
	10	1.60	2.26	2.76	3.19	3.91	4.51	5.05	5.53	6.39	-	-	-
	12.5	2.00	2.82	3.46	3.99	4.89	5.64	6.31	6.91	7.98	-	-	-
	15	2.39	3.39	4.15	4.79	5.87	6.77	7.57	8.29	9.58	-	-	-
	20	3.19	4.51	5.53	6.39	7.82	9.03	10.10	11.06	12.77	-	-	-
	25	3.99	5.64	6.91	7.98	9.78	11.29	12.62	13.82	15.96	-	-	-
30	4.79	6.77	8.29	9.58	11.73	13.54	15.14	16.59	19.16	-	-	-	

※ For MPa / bar / psi units, please refer to LORRIC.com.

Spray Angle	Capacity Code	Capacity at Pressure									Average particle size (um)	Min. Free Passage (mm)	Filter mesh
		0.5 kgf/cm ²	1 kgf/cm ²	1.5 kgf/cm ²	2 kgf/cm ²	3 kgf/cm ²	4 kgf/cm ²	5 kgf/cm ²	6 kgf/cm ²	8 kgf/cm ²			
50°	2	0.32	0.45	0.55	0.64	0.78	0.90	1.01	1.11	1.28	-	-	-
	2.5	0.40	0.56	0.69	0.80	0.98	1.13	1.26	1.38	1.60	-	-	-
	3	0.48	0.68	0.83	0.96	1.17	1.35	1.51	1.66	1.92	-	-	-
	4	0.64	0.90	1.11	1.28	1.56	1.81	2.02	2.21	2.55	-	-	-
	5	0.80	1.13	1.38	1.60	1.96	2.26	2.52	2.76	3.19	-	-	-
	6	0.96	1.35	1.66	1.92	2.35	2.71	3.03	3.32	3.83	-	-	-
	7	1.12	1.58	1.94	2.23	2.74	3.16	3.53	3.87	4.47	-	-	-
	7.5	1.20	1.69	2.07	2.39	2.93	3.39	3.79	4.15	4.79	-	-	-
	8	1.28	1.81	2.21	2.55	3.13	3.61	4.04	4.42	5.11	-	-	-
	9	1.44	2.03	2.49	2.87	3.52	4.06	4.54	4.98	5.75	-	-	-
	10	1.60	2.26	2.76	3.19	3.91	4.51	5.05	5.53	6.39	-	-	-
	12.5	2.00	2.82	3.46	3.99	4.89	5.64	6.31	6.91	7.98	-	-	-
	15	2.39	3.39	4.15	4.79	5.87	6.77	7.57	8.29	9.58	-	-	-
	20	3.19	4.51	5.53	6.39	7.82	9.03	10.10	11.06	12.77	-	-	-
	25	3.99	5.64	6.91	7.98	9.78	11.29	12.62	13.82	15.96	-	-	-
30	4.79	6.77	8.29	9.58	11.73	13.54	15.14	16.59	19.16	-	-	-	
65°	2	0.32	0.45	0.55	0.64	0.78	0.90	1.01	1.11	1.28	-	0.4	150
	2.5	0.40	0.56	0.69	0.80	0.98	1.13	1.26	1.38	1.60	-	0.6	100
	3	0.48	0.68	0.83	0.96	1.17	1.35	1.51	1.66	1.92	-	0.7	100
	4	0.64	0.90	1.11	1.28	1.56	1.81	2.02	2.21	2.55	-	0.8	50
	5	0.80	1.13	1.38	1.60	1.96	2.26	2.52	2.76	3.19	-	0.9	50
	6	0.96	1.35	1.66	1.92	2.35	2.71	3.03	3.32	3.83	230	0.9	50
	7	1.12	1.58	1.94	2.23	2.74	3.16	3.53	3.87	4.47	-	1.0	-
	7.5	1.20	1.69	2.07	2.39	2.93	3.39	3.79	4.15	4.79	-	1.0	-
	8	1.28	1.81	2.21	2.55	3.13	3.61	4.04	4.42	5.11	-	1.1	-
	9	1.44	2.03	2.49	2.87	3.52	4.06	4.54	4.98	5.75	-	1.1	-
	10	1.60	2.26	2.76	3.19	3.91	4.51	5.05	5.53	6.39	-	1.2	-
	12.5	2.00	2.82	3.46	3.99	4.89	5.64	6.31	6.91	7.98	-	1.3	-
	15	2.39	3.39	4.15	4.79	5.87	6.77	7.57	8.29	9.58	-	1.4	-
	20	3.19	4.51	5.53	6.39	7.82	9.03	10.10	11.06	12.77	370	1.6	-
	25	3.99	5.64	6.91	7.98	9.78	11.29	12.62	13.82	15.96	-	2.0	-
30	4.79	6.77	8.29	9.58	11.73	13.54	15.14	16.59	19.16	-	2.3	-	
80°	2	0.32	0.45	0.55	0.64	0.78	0.90	1.01	1.11	1.28	-	0.3	150
	2.5	0.40	0.56	0.69	0.80	0.98	1.13	1.26	1.38	1.60	-	0.4	150
	3	0.48	0.68	0.83	0.96	1.17	1.35	1.51	1.66	1.92	-	0.4	150
	4	0.64	0.90	1.11	1.28	1.56	1.81	2.02	2.21	2.55	-	0.6	100
	5	0.80	1.13	1.38	1.60	1.96	2.26	2.52	2.76	3.19	220	0.7	50
	6	0.96	1.35	1.66	1.92	2.35	2.71	3.03	3.32	3.83	-	0.7	50
	7	1.12	1.58	1.94	2.23	2.74	3.16	3.53	3.87	4.47	-	0.9	50
	7.5	1.20	1.69	2.07	2.39	2.93	3.39	3.79	4.15	4.79	-	0.9	50
	8	1.28	1.81	2.21	2.55	3.13	3.61	4.04	4.42	5.11	-	1.0	-
	9	1.44	2.03	2.49	2.87	3.52	4.06	4.54	4.98	5.75	-	1.0	-
	10	1.60	2.26	2.76	3.19	3.91	4.51	5.05	5.53	6.39	-	1.1	-
	12.5	2.00	2.82	3.46	3.99	4.89	5.64	6.31	6.91	7.98	-	1.3	-
	15	2.39	3.39	4.15	4.79	5.87	6.77	7.57	8.29	9.58	-	1.4	-
	20	3.19	4.51	5.53	6.39	7.82	9.03	10.10	11.06	12.77	340	1.6	-
	25	3.99	5.64	6.91	7.98	9.78	11.29	12.62	13.82	15.96	-	1.9	-
30	4.79	6.77	8.29	9.58	11.73	13.54	15.14	16.59	19.16	-	2.1	-	

※ For MPa / bar / psi units, please refer to LORRIC.com.

Spray Angle	Capacity Code	Capacity at Pressure									Average particle size (um)	Min. Free Passage (mm)	Filter mesh
		0.5 kgf/cm ²	1 kgf/cm ²	1.5 kgf/cm ²	2 kgf/cm ²	3 kgf/cm ²	4 kgf/cm ²	5 kgf/cm ²	6 kgf/cm ²	8 kgf/cm ²			
90°	2	0.32	0.45	0.55	0.64	0.78	0.90	1.01	1.11	1.28	-	0.3	150
	2.5	0.40	0.56	0.69	0.80	0.98	1.13	1.26	1.38	1.60	-	0.4	150
	3	0.48	0.68	0.83	0.96	1.17	1.35	1.51	1.66	1.92	-	0.4	150
	4	0.64	0.90	1.11	1.28	1.56	1.81	2.02	2.21	2.55	-	0.5	100
	5	0.80	1.13	1.38	1.60	1.96	2.26	2.52	2.76	3.19	-	0.5	100
	6	0.96	1.35	1.66	1.92	2.35	2.71	3.03	3.32	3.83	210	0.5	100
	7	1.12	1.58	1.94	2.23	2.74	3.16	3.53	3.87	4.47	-	0.6	100
	7.5	1.20	1.69	2.07	2.39	2.93	3.39	3.79	4.15	4.79	-	0.8	50
	8	1.28	1.81	2.21	2.55	3.13	3.61	4.04	4.42	5.11	330	0.8	50
	9	1.44	2.03	2.49	2.87	3.52	4.06	4.54	4.98	5.75	-	0.8	50
	10	1.60	2.26	2.76	3.19	3.91	4.51	5.05	5.53	6.39	-	1.0	-
	12.5	2.00	2.82	3.46	3.99	4.89	5.64	6.31	6.91	7.98	-	1.1	-
	15	2.39	3.39	4.15	4.79	5.87	6.77	7.57	8.29	9.58	-	1.2	-
	20	3.19	4.51	5.53	6.39	7.82	9.03	10.10	11.06	12.77	-	1.4	-
	25	3.99	5.64	6.91	7.98	9.78	11.29	12.62	13.82	15.96	-	1.6	-
	30	4.79	6.77	8.29	9.58	11.73	13.54	15.14	16.59	19.16	-	1.8	-
100°	2	0.32	0.45	0.55	0.64	0.78	0.90	1.01	1.11	1.28	-	-	-
	2.5	0.40	0.56	0.69	0.80	0.98	1.13	1.26	1.38	1.60	-	-	-
	3	0.48	0.68	0.83	0.96	1.17	1.35	1.51	1.66	1.92	-	-	-
	4	0.64	0.90	1.11	1.28	1.56	1.81	2.02	2.21	2.55	-	-	-
	5	0.80	1.13	1.38	1.60	1.96	2.26	2.52	2.76	3.19	-	-	-
	6	0.96	1.35	1.66	1.92	2.35	2.71	3.03	3.32	3.83	-	-	-
	7	1.12	1.58	1.94	2.23	2.74	3.16	3.53	3.87	4.47	-	-	-
	7.5	1.20	1.69	2.07	2.39	2.93	3.39	3.79	4.15	4.79	-	-	-
	8	1.28	1.81	2.21	2.55	3.13	3.61	4.04	4.42	5.11	-	-	-
	9	1.44	2.03	2.49	2.87	3.52	4.06	4.54	4.98	5.75	-	-	-
	10	1.60	2.26	2.76	3.19	3.91	4.51	5.05	5.53	6.39	-	-	-
	12.5	2.00	2.82	3.46	3.99	4.89	5.64	6.31	6.91	7.98	-	-	-
	15	2.39	3.39	4.15	4.79	5.87	6.77	7.57	8.29	9.58	-	-	-
	20	3.19	4.51	5.53	6.39	7.82	9.03	10.10	11.06	12.77	-	-	-
	25	3.99	5.64	6.91	7.98	9.78	11.29	12.62	13.82	15.96	-	-	-
	30	4.79	6.77	8.29	9.58	11.73	13.54	15.14	16.59	19.16	-	-	-
110°	2	0.32	0.45	0.55	0.64	0.78	0.90	1.01	1.11	1.28	-	-	-
	2.5	0.40	0.56	0.69	0.80	0.98	1.13	1.26	1.38	1.60	-	-	-
	3	0.48	0.68	0.83	0.96	1.17	1.35	1.51	1.66	1.92	-	-	-
	4	0.64	0.90	1.11	1.28	1.56	1.81	2.02	2.21	2.55	-	-	-
	5	0.80	1.13	1.38	1.60	1.96	2.26	2.52	2.76	3.19	-	-	-
	6	0.96	1.35	1.66	1.92	2.35	2.71	3.03	3.32	3.83	-	-	-
	7	1.12	1.58	1.94	2.23	2.74	3.16	3.53	3.87	4.47	-	-	-
	7.5	1.20	1.69	2.07	2.39	2.93	3.39	3.79	4.15	4.79	-	-	-
	8	1.28	1.81	2.21	2.55	3.13	3.61	4.04	4.42	5.11	-	-	-
	9	1.44	2.03	2.49	2.87	3.52	4.06	4.54	4.98	5.75	-	-	-
	10	1.60	2.26	2.76	3.19	3.91	4.51	5.05	5.53	6.39	-	-	-
	12.5	2.00	2.82	3.46	3.99	4.89	5.64	6.31	6.91	7.98	-	-	-
	15	2.39	3.39	4.15	4.79	5.87	6.77	7.57	8.29	9.58	-	-	-
	20	3.19	4.51	5.53	6.39	7.82	9.03	10.10	11.06	12.77	-	-	-
	25	3.99	5.64	6.91	7.98	9.78	11.29	12.62	13.82	15.96	-	-	-
	30	4.79	6.77	8.29	9.58	11.73	13.54	15.14	16.59	19.16	-	-	-

※ For MPa / bar / psi units, please refer to LORRIC.com.

DVEH Easy maintenance plastic flat fan nozzle



- Flowrate tolerance: $\pm 5\%$ @ 2.0 ± 0.1 kgf/cm²
- Angle tolerance: $\pm 5^\circ$ @ 2.0 ± 0.1 kgf/cm²
- Jet angle tolerance: 3°

【 Top view of nozzle spray pattern 】



【 Flow distribution 】

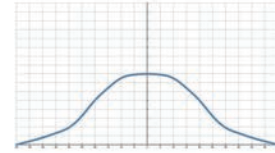

Features

- The spraying type is fan type, and the spray shape is single line and two sides are tapered (tapered edge), which presents a bell curve shape flow field distribution with weaker ends compared to the middle.
- Multi-piece structure, easy maintenance, cleaning and replacement, and can save the cost of replacing the nozzle head.
- The special positioning design of the nozzle and base installation ensures that each nozzle can be replaced and returned to the original position.
- No internal gasket design to avoid possible water leakage or contamination of the gasket.
- PVDF is resistant to temperature and corrosive chemical solutions.

Applications

- Cleaning: Vehicles, Containers, Filters, Dust, Gravel, Metals, Metal Parts, Machinery, Steel Plates, Various Containers, etc.
- Cooling: Gas, tank, machinery, metal, roof, etc.
- Dispersion: Humidifying, chemicals (eg. etching solution, developer, insect repellent, etc.), firefighting, dedust, deodorization, etc.
- Printed circuit board: etching process, developing process, water washing process.

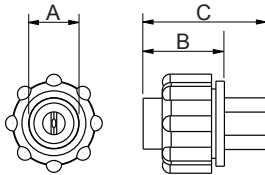

Appearance dimensions may vary depending on model, material. Please ask for details.

Material	Serie	Unit (mm)			Thread Type	Weight (g)
		A	B	C		
Plastic	DVEH	48	20	31	-	28.2

Material

- Tip: PVDF
- Body: U-PVC
- Clap: PP

How to place an order for LORRIC nozzles?

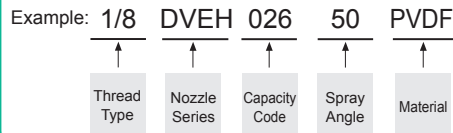

※ Standard Pressure: Column in red.

Spray Angle	Capacity Code	Capacity at Pressure									Average particle size (um)	Min. Free Passage (mm)	Filter mesh
		0.7 kgf/cm ²	1 kgf/cm ²	1.5 kgf/cm ²	2 kgf/cm ²	3 kgf/cm ²	4 kgf/cm ²	5 kgf/cm ²	6 kgf/cm ²	8 kgf/cm ²			
50°	15	0.89	1.06	1.30	1.50	1.84	2.12	2.37	2.60	3.00	-	0.9	50
	26	1.54	1.84	2.25	2.60	3.18	3.68	4.11	4.50	5.20	-	1.1	-
80°	12	0.71	0.85	1.04	1.20	1.47	1.70	1.90	2.08	2.40	-	0.7	100

※ For MPa / bar / psi units, please refer to LORRIC.com.

D Clamp Easy maintenance low pressure and wide angle flat fan nozzle with pipe clamp

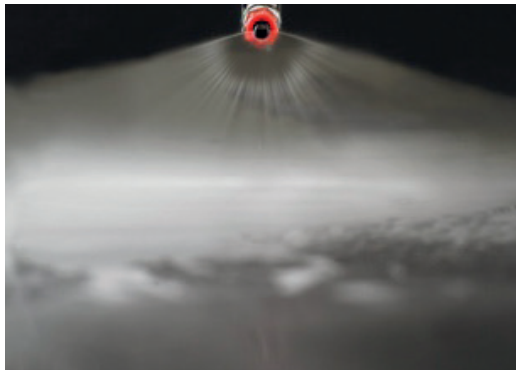

- Recommended working pressure: 1.5 kgf/cm²
- Flowrate tolerance: ± 10% @ 1.5 ± 0.1kgf/cm²
- Angle tolerance: ± 10° @ 1.5 ± 0.1kgf/cm²

【 Top view of nozzle spray pattern 】



【 Flow distribution 】

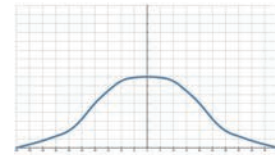

Features

- The spray pattern is fan type, and the spray shape is single-line.
- Low-pressure wide-angle nozzles can achieve large angle coverage under 1.5kgf/cm² pressure. The coverage area is smaller than the standard fan type 3kgf/cm² operating pressure, and is more suitable for low-pressure working environment.
- Spray the nozzle at an angle of 75° with respect to the axis of the nozzle. Check the environment before installation.
- The hooked nozzle tip is designed to reflect the water into a fan shape nozzle and greaten particle passage to prevent clogging.
- Multi-piece structure, easy maintenance, cleaning and

replacement, and can save the cost of replacement nozzle head.

- size:
 - Spec of drilling installation hole: 8.35~9mm
 - Size of Pipe clamp:3/4"(OD26 +/-0.2mm),1"(OD34+/-0.3mm)
- If operation pressure is greater than 4kgf/cm²,May cause the liquid to overflow without fogging.

Applications

- Cleaning: Conveyor belt, film, copper thin, paper, glass plate, all kinds of plates, filters, dust and gravel, and machine tool cleaning.
- Cooling: Conveyor belts, gas, tank, machinery, metal, roof, etc.
- Dispersion: Humidifying, chemicals, firefighting, dedust, deodorization, defoaming, etc.

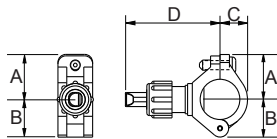

Appearance dimensions may vary depending on model, material. Please ask for details.

Material	Serie	Unit (mm)				Pipe Type	Weight (g)
		A	B	C	D		
Plastic	3/4DClamp	23	28	18	64	3/4M	23.6
	1 DClamp	28.5	33	23.5	64	1M	

Material

- Nozzle: PP
- Clamp: Strengthened Fiberglass PP

How to place an order for LORRIC nozzles?

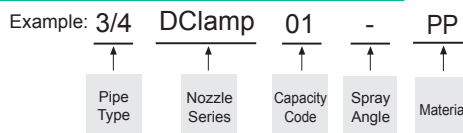

※ Standard Pressure: Column in red.

Spray Angle	Capacity Code	Thread Size		Capacity at Pressure									Average particle size (um)	Min. Free Passage (mm)	Filter mesh
		1	3/4	0.5 kgf/cm ²	0.7 kgf/cm ²	1 kgf/cm ²	1.5 kgf/cm ²	2 kgf/cm ²	2.5 kgf/cm ²	3 kgf/cm ²	4 kgf/cm ²	5 kgf/cm ²			
110°	0.5	v	v	0.16	0.19	0.23	0.28	0.32	0.36	0.40	0.46	0.51	150	0.5	100
125°	0.75	v	v	0.24	0.29	0.34	0.42	0.48	0.54	0.59	0.69	0.77	-	0.7	50
120°	1	v	v	0.32	0.38	0.46	0.56	0.65	0.72	0.79	0.91	1.02	-	0.8	50
130°	1.5	v	v	0.48	0.57	0.69	0.84	0.97	1.08	1.19	1.37	1.53	-	0.8	50
145°	2	v	v	0.65	0.77	0.91	1.12	1.29	1.45	1.58	1.83	2.04	200	1.1	-
	3	v	v	0.97	1.15	1.37	1.68	1.94	2.17	2.38	2.74	3.07	-	1.4	-
170°	5	v	v	1.62	1.91	2.29	2.80	3.23	3.61	3.96	4.57	5.11	-	1.7	-

※ For MPa / bar / psi units, please refer to LORRIC.com.

KAD Flat fan nozzle



【 Top view of nozzle spray pattern 】



【 Flow distribution 】

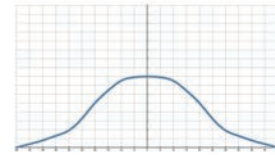

- Recommended working pressure: 3.0 kgf/cm²
- Flowrate tolerance: ± 5% @ 3.0 ± 0.1 kgf/cm²
- Angle tolerance: ± 5° @ 3.0 ± 0.1 kgf/cm²
- Jet angle tolerance: 3°

Features

- The spraying type is fan type, and the spray shape is single line and two sides are tapered (tapered edge), which presents a bell curve shape flow field distribution with weaker ends compared to the middle.
- Three-piece structure facilitates maintenance cleaning and replacement, and can save the cost of replacing the nozzle head. The base must be connected to the pipeline by welding.

Please confirm that the installation environment meets the requirements.

- The special positioning design of the nozzle and base installation ensures that each spray replacement can be returned to the original positioning.

Applications

- Cleaning: Vehicles, containers, filters, dust, gravel, metals, metal parts, mechanical, steel plates, various containers, high Pressure cleaning, wet processing, display panel, machinery washing, etc.
- Cooling: Gas, tank, machinery, metal, roof, etc.
- Dispersion: Humidifying, chemicals (etching solution, developer, insect repellent, etc.), Water Curtain (fire, dust, deodorant, etc.).

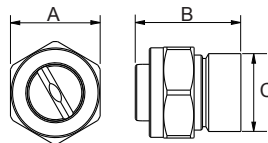

Appearance dimensions may vary depending on model, material. Please ask for details.

Material	Serie	Unit (mm)		Thread Type	Weight (g)		
		A	B		S303	S316	Brass
Metal	KAD	32	38	-	162	165	180

Material

- Metal: Stainless 303, Stainless 316, BRASS

How to place an order for LORRIC nozzles?

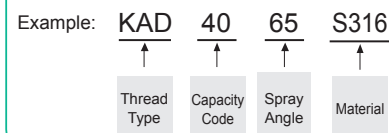

※ Standard Pressure: Column in red.

Spray Angle	Capacity Code	Capacity at Pressure									Average particle size (um)	Min. Free Passage (mm)	Filter mesh
		0.7 kgf/cm ²	1 kgf/cm ²	1.5 kgf/cm ²	2 kgf/cm ²	3 kgf/cm ²	4 kgf/cm ²	5 kgf/cm ²	6 kgf/cm ²	8 kgf/cm ²			
65°	40	7.55	9.03	11.06	12.77	15.64	18.06	20.19	22.12	25.54	-	2.5	-
50°	50	9.44	11.29	13.82	15.96	19.55	22.57	25.24	27.65	31.93	-	2.8	-

※ For MPa / bar / psi units, please refer to LORRIC.com.

HB Angle adjustable and easy install flat fan nozzle with pipe clamp



【 Top view of nozzle spray pattern 】



【 Flow distribution 】

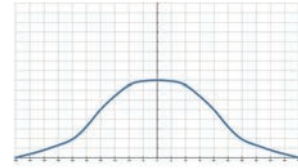

- Recommended working pressure: 1.0 kgf/cm²
- Flowrate tolerance: ± 10% @ 1.0 ± 0.1 kgf/cm²
- Angle tolerance: ± 10° @ 1.0 ± 0.1 kgf/cm²

Features

- The spraying type is fan type, and the spray shape is single line and two sides are tapered (tapered edge), which presents a bell curve shape flow field distribution with weaker ends compared to the middle.
- Unique pipe clamp design allows to be installed by drilling in the pipeline without any tools.
- Three-piece structure design, divided into nozzle part (HB), base part (EB) and nuts, which facilitates maintenance cleaning and replacement, and can save the cost of replacing the nozzle head.
- Double gasket seal design, between the nozzle and the base, and between the base and the pipeline, are sealed by NBR gasket to ensure no water leakage.
- The nozzle part is designed as a sphere, and the nozzle axis is anisotropically adjusted by 50°.
- Spec of drilling installation hole:
 - Ø 15 (14.3~15mm) - Ø 17 (16.4~17mm)
 - Ø 20 (19.0~20mm) 8.35 ~ 9m/m
- Size of Pipe clamp:
 - 1" (OD34 +/-0.3mm) - 1-1/4" (OD42 +/-0.3mm)
 - 1-1/2" (OD48 +/-0.4mm)
- If there is any other spray type or material request, please choose TB adapter (with choices of 1/4" and 3/8" internal threads) and general fan or cone nozzles with optional materials.

Applications

- Cleaning: Pretreatment for painting in automotive and home appliance manufacturing industries.

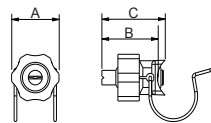

Appearance dimensions may vary depending on model, material. Please ask for details.

Material	Serie	Unit (mm)			Thread Type	Weight (g)
		A	B	C		
Plastic	HB	52	62	70	-	62.5

Material

- Nozzle: PP
- Clamp, nut: fiberglass, Strengthening PP
- Pipe clamp: Stainless 316
- Sealing ring: NBR

How to place an order for LORRIC nozzles?

Example: **1"** **EB15** **HB** **10** **65** **PP**

↑ ↑ ↑ ↑ ↑ ↑

Pipe Type Nozzle Series Nozzle Series Capacity Code Spray Angle Material

※ Standard Pressure: Column in red.

Spray Angle	Capacity Code	HB Color	Capacity at Pressure								
			0.5 kgf/cm ²	0.7 kgf/cm ²	1 kgf/cm ²	1.5 kgf/cm ²	2 kgf/cm ²	2.5 kgf/cm ²	3 kgf/cm ²	3.5 kgf/cm ²	4 kgf/cm ²
65°	10	Sky Blue	1.60	1.89	2.26	2.77	3.20	3.57	3.91	4.23	4.52
	20	Red	3.20	3.78	4.52	5.54	6.39	7.15	7.83	8.46	9.04
	30	Orange	4.79	5.66	6.77	8.29	9.57	10.70	11.73	12.67	13.54
	35	Black	5.59	6.61	7.90	9.68	11.17	12.49	13.68	14.78	15.80
	40	Yellow	6.39	7.56	9.03	11.06	12.77	14.28	15.64	16.89	18.06
	50	Blue	7.98	9.45	11.29	13.83	15.97	17.85	19.55	21.12	22.58
	60	Green	9.58	11.34	13.55	16.60	19.16	21.42	23.47	25.35	27.10
80°	10	Sky Blue	1.60	1.89	2.26	2.77	3.20	3.57	3.91	4.23	4.52
	20	Red	3.20	3.78	4.52	5.54	6.39	7.15	7.83	8.46	9.04
	30	Orange	4.79	5.66	6.77	8.29	9.57	10.70	11.73	12.67	13.54
	35	Black	5.59	6.61	7.90	9.68	11.17	12.49	13.68	14.78	15.80
	40	Yellow	6.39	7.56	9.03	11.06	12.77	14.28	15.64	16.89	18.06
	50	Blue	7.98	9.45	11.29	13.83	15.97	17.85	19.55	21.12	22.58
	60	Green	9.58	11.34	13.55	16.60	19.16	21.42	23.47	25.35	27.10

※ For MPa / bar / psi units, please refer to LORRIC.com.

Full Cone Nozzles



KP M	42
KP P	44
KH	46
QSF	47
QFF.....	48
QFMF	50
QFYF	52
QFYMF	54
QT	56
KDMF	57
KPMF M.....	58
KPMF P	60
KJ	62
KG	63

KP M Metal clog-resistant full cone nozzle



【Top view of nozzle spray pattern】



【Flow distribution】

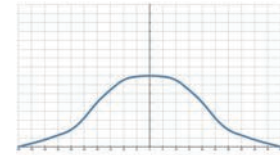

- Recommended working pressure: 2.0 kgf/cm²
- Flowrate tolerance: ± 5% @ 2.0 ± 0.1 kgf/cm²
- Angle tolerance: ± 5° @ 2.0 ± 0.1 kgf/cm²

Features

- Full cone spray.
- Unibody design allows for secure and easy installation, and X-shaped core provides minimal clogging.

Applications

- Cleaning: Gas, exhaust gas, dust, cleaning device, tank cleaning, etc.
- Cooling: Gas, tank, machinery, metal, roof, etc.
- Dispersion: humidifying, chemicals, firefighting, dust suppression, aeration, defoaming, sewage treatment.

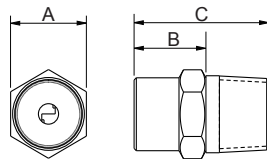

Appearance dimensions may vary depending on model, material. Please ask for details.

Material	Serie	Unit (mm)			Thread Type	Weight(g)		
		A	B	C		S303	S316	Brass
Metal	1/8KP (M)	12	12	19	1/8M	15	15.5	16.9
	1/4KP (M)	14	11-15	22-26	1/4M	18	18.5	19
	3/8KP (M)	18	15	30	3/8M	28.5	29	32

Material

- Metal: Stainless 303, Stainless 316, BRASS

How to place an order for LORRIC nozzles?

Example: 1/8 BSPT KP 20 S303

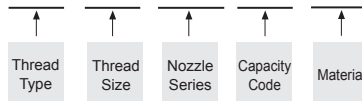

※ Standard Pressure: Column in red.
 ※ This product for spray angle 90° and 120° is able to be made to order.

Spray Angle	Capacity Code	Thread Size			Capacity at Pressure									Average particle size (um)	Min. Free Passage (mm)	Filter mesh
		1/8	1/4	3/8	0.7 kgf/cm ²	1 kgf/cm ²	1.5 kgf/cm ²	2 kgf/cm ²	4 kgf/cm ²	6 kgf/cm ²	8 kgf/cm ²	10 kgf/cm ²	15 kgf/cm ²			
90°	10	V	V		0.59	0.71	0.87	1.00	1.41	1.73	2.00	2.24	2.74	230	0.7	100
	15	V	V		0.89	1.06	1.30	1.50	2.12	2.60	3.00	3.35	4.11		1	-
	20	V	V		1.18	1.41	1.73	2.00	2.83	3.46	4.00	4.47	5.48			1.3
	25	V	V		1.48	1.77	2.17	2.50	3.54	4.33	5.00	5.59	6.85	1.4	-	
	30	V	V		1.77	2.12	2.60	3.00	4.24	5.20	6.00	6.71	8.22		1.5	-
	35	V	V		2.07	2.47	3.03	3.50	4.95	6.06	7.00	7.83	9.59			1.6
	40	V	V		2.37	2.83	3.46	4.00	5.66	6.93	8.00	8.94	10.95	1.7	-	
	50		V	V	2.96	3.54	4.33	5.00	7.07	8.66	10.00	11.18	13.69		400	1.7
	60		V	V	3.55	4.24	5.20	6.00	8.49	10.39	12.00	13.42	16.43	1.7		-
	70		V	V	4.14	4.95	6.06	7.00	9.90	12.12	14.00	15.65	19.17			1.9
	80		V	V	4.73	5.66	6.93	8.00	11.31	13.86	16.00	17.89	21.91	1.9	-	
	100			V	5.92	7.07	8.66	10.00	14.14	17.32	20.00	22.36	27.39		2	
120			V	7.10	8.49	10.39	12.00	16.97	20.78	24.00	26.83	32.86	2.1	-		
95°	140			V	8.28	9.90	12.12	14.00	19.80	24.25	28.00	31.30		38.34	640	2.5

※ For MPa / bar / psi units, please refer to LORRIC.com.

Spray Angle	Capacity Code	Thread Size			Capacity at Pressure									Average particle size (um)	Min. Free Passage (mm)	Filter mesh
		1/8	1/4	3/8	0.7 kgf/cm ²	1 kgf/cm ²	1.5 kgf/cm ²	2 kgf/cm ²	4 kgf/cm ²	6 kgf/cm ²	8 kgf/cm ²	10 kgf/cm ²	15 kgf/cm ²			
90°	10	V	V		0.59	0.71	0.87	1.00	1.41	1.73	2.00	2.24	2.74	-	-	-
	15	V	V		0.89	1.06	1.30	1.50	2.12	2.60	3.00	3.35	4.11	-	-	-
	20	V	V		1.18	1.41	1.73	2.00	2.83	3.46	4.00	4.47	5.48	-	-	-
	25	V	V		1.48	1.77	2.17	2.50	3.54	4.33	5.00	5.59	6.85	-	-	-
	30	V	V		1.77	2.12	2.60	3.00	4.24	5.20	6.00	6.71	8.22	-	-	-
	35	V	V		2.07	2.47	3.03	3.50	4.95	6.06	7.00	7.83	9.59	-	-	-
	40	V	V		2.37	2.83	3.46	4.00	5.66	6.93	8.00	8.94	10.95	-	-	-
	50		V	V	2.96	3.54	4.33	5.00	7.07	8.66	10.00	11.18	13.69	-	-	-
	60		V	V	3.55	4.24	5.20	6.00	8.49	10.39	12.00	13.42	16.43	-	-	-
	70		V	V	4.14	4.95	6.06	7.00	9.90	12.12	14.00	15.65	19.17	-	-	-
	80		V	V	4.73	5.66	6.93	8.00	11.31	13.86	16.00	17.89	21.91	-	-	-
	100			V	5.92	7.07	8.66	10.00	14.14	17.32	20.00	22.36	27.39	-	-	-
	120			V	7.10	8.49	10.39	12.00	16.97	20.78	24.00	26.83	32.86	-	-	-
	140			V	8.28	9.90	12.12	14.00	19.80	24.25	28.00	31.30	38.34	-	-	-
120°	10	V	V		0.59	0.71	0.87	1.00	1.41	1.73	2.00	2.24	2.74	-	-	-
	15	V	V		0.89	1.06	1.30	1.50	2.12	2.60	3.00	3.35	4.11	-	-	-
	20	V	V		1.18	1.41	1.73	2.00	2.83	3.46	4.00	4.47	5.48	-	-	-
	25	V	V		1.48	1.77	2.17	2.50	3.54	4.33	5.00	5.59	6.85	-	-	-
	30	V	V		1.77	2.12	2.60	3.00	4.24	5.20	6.00	6.71	8.22	-	-	-
	35	V	V		2.07	2.47	3.03	3.50	4.95	6.06	7.00	7.83	9.59	-	-	-
	40	V	V		2.37	2.83	3.46	4.00	5.66	6.93	8.00	8.94	10.95	-	-	-
	50		V	V	2.96	3.54	4.33	5.00	7.07	8.66	10.00	11.18	13.69	-	-	-
	60		V	V	3.55	4.24	5.20	6.00	8.49	10.39	12.00	13.42	16.43	-	-	-
	70		V	V	4.14	4.95	6.06	7.00	9.90	12.12	14.00	15.65	19.17	-	-	-
	80		V	V	4.73	5.66	6.93	8.00	11.31	13.86	16.00	17.89	21.91	-	-	-
	100			V	5.92	7.07	8.66	10.00	14.14	17.32	20.00	22.36	27.39	-	-	-
	120			V	7.10	8.49	10.39	12.00	16.97	20.78	24.00	26.83	32.86	-	-	-
	140			V	8.28	9.90	12.12	14.00	19.80	24.25	28.00	31.30	38.34	-	-	-

※ For MPa / bar / psi units, please refer to LORRIC.com.

KP P Plastic clog-resistant full cone nozzle



【 Top view of nozzle spray pattern 】

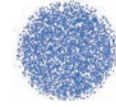

【 Flow distribution 】

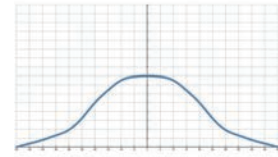

- Recommended working pressure: 2.0 kgf/cm²
- Flowrate tolerance: ± 5% @ 2.0 ± 0.1 kgf/cm²
- Angle tolerance: ± 5° @ 2.0 ± 0.1 kgf/cm²

Features

- Full cone spray.
- Unibody design allows for secure and easy installation, and X-shaped core provides minimal clogging.
- PVDF is resistant to temperature and corrosive chemical solutions.

Applications

- Cleaning: Gas, exhaust gas, dust, cleaning device, tank cleaning, etc.
- Cooling: Gas, tank, machinery, metal, roof, etc.
- Dispersion: humidifying, chemicals, firefighting, dust suppression, aeration, defoaming, sewage treatment.

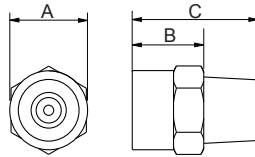

Appearance dimensions may vary depending on model, material. Please ask for details.

Material	Serie	Unit (mm)			Thread Type	Weight (g)
		A	B	C		
Plastic	1/8KP (P)	12	10	19	1/8M	1.0
	1/4KP (P)	15	11	21	1/4M	5.0
	3/8KP (P)	17	13	25	3/8M	5.5

Material

- Body: PVDF
- CORE: PP

How to place an order for LORRIC nozzles?

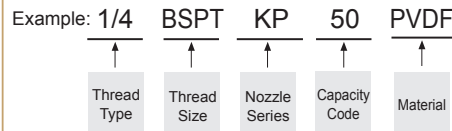

※ Standard Pressure: Column in red.
 ※ This product for spray angle 90° and 120° is able to be made to order.

Spray Angle	Capacity Code	Thread Size			Capacity at Pressure									Average particle size (um)	Min. Free Passage (mm)	Filter mesh										
		1/8	1/4	3/8	0.7 kgf/cm ²	1 kgf/cm ²	1.5 kgf/cm ²	2 kgf/cm ²	4 kgf/cm ²	6 kgf/cm ²	8 kgf/cm ²	10 kgf/cm ²	15 kgf/cm ²													
50°	10	V	V		0.59	0.71	0.87	1.00	1.41	1.73	2.00	2.24	2.74	230	0.7	100										
	15	V	V		0.89	1.06	1.30	1.50	2.12	2.60	3.00	3.35	4.11		}	1	-									
	20	V	V		1.18	1.41	1.73	2.00	2.83	3.46	4.00	4.47	5.48			270	1.3	-								
	25	V	V		1.48	1.77	2.17	2.50	3.54	4.33	5.00	5.59	6.85				}	1.4	-							
	30	V	V		1.77	2.12	2.60	3.00	4.24	5.20	6.00	6.71	8.22					}	1.5	-						
	35	V	V		2.07	2.47	3.03	3.50	4.95	6.06	7.00	7.83	9.59						}	1.6	-					
	40	V	V		2.37	2.83	3.46	4.00	5.66	6.93	8.00	8.94	10.95							400	1.7	-				
	50		V	V	2.96	3.54	4.33	5.00	7.07	8.66	10.00	11.18	13.69								}	1.7	-			
	60		V	V	3.55	4.24	5.20	6.00	8.49	10.39	12.00	13.42	16.43									}	1.7	-		
	70		V	V	4.14	4.95	6.06	7.00	9.90	12.12	14.00	15.65	19.17										}	1.9	-	
	80		V	V	4.73	5.66	6.93	8.00	11.31	13.86	16.00	17.89	21.91											}	1.9	-
	100			V	5.92	7.07	8.66	10.00	14.14	17.32	20.00	22.36	27.39												}	2
120			V	7.10	8.49	10.39	12.00	16.97	20.78	24.00	26.83	32.86	}	2.1												-
95°	140			V	8.28	9.90	12.12	14.00	19.80	24.25	28.00	31.30		38.34	640											2.5

※ For MPa / bar / psi units, please refer to LORRIC.com.

Spray Angle	Capacity Code	Thread Size			Capacity at Pressure									Average particle size (um)	Min. Free Passage (mm)	Filter mesh
		1/8	1/4	3/8	0.7 kgf/cm ²	1 kgf/cm ²	1.5 kgf/cm ²	2 kgf/cm ²	4 kgf/cm ²	6 kgf/cm ²	8 kgf/cm ²	10 kgf/cm ²	15 kgf/cm ²			
90°	10	V	V		0.59	0.71	0.87	1.00	1.41	1.73	2.00	2.24	2.74	-	-	-
	15	V	V		0.89	1.06	1.30	1.50	2.12	2.60	3.00	3.35	4.11	-	-	-
	20	V	V		1.18	1.41	1.73	2.00	2.83	3.46	4.00	4.47	5.48	-	-	-
	25	V	V		1.48	1.77	2.17	2.50	3.54	4.33	5.00	5.59	6.85	-	-	-
	30	V	V		1.77	2.12	2.60	3.00	4.24	5.20	6.00	6.71	8.22	-	-	-
	35	V	V		2.07	2.47	3.03	3.50	4.95	6.06	7.00	7.83	9.59	-	-	-
	40	V	V		2.37	2.83	3.46	4.00	5.66	6.93	8.00	8.94	10.95	-	-	-
	50		V	V	2.96	3.54	4.33	5.00	7.07	8.66	10.00	11.18	13.69	-	-	-
	60		V	V	3.55	4.24	5.20	6.00	8.49	10.39	12.00	13.42	16.43	-	-	-
	70		V	V	4.14	4.95	6.06	7.00	9.90	12.12	14.00	15.65	19.17	-	-	-
	80		V	V	4.73	5.66	6.93	8.00	11.31	13.86	16.00	17.89	21.91	-	-	-
	100			V	5.92	7.07	8.66	10.00	14.14	17.32	20.00	22.36	27.39	-	-	-
	120			V	7.10	8.49	10.39	12.00	16.97	20.78	24.00	26.83	32.86	-	-	-
	140			V	8.28	9.90	12.12	14.00	19.80	24.25	28.00	31.30	38.34	-	-	-
120°	10	V	V		0.59	0.71	0.87	1.00	1.41	1.73	2.00	2.24	2.74	-	-	-
	15	V	V		0.89	1.06	1.30	1.50	2.12	2.60	3.00	3.35	4.11	-	-	-
	20	V	V		1.18	1.41	1.73	2.00	2.83	3.46	4.00	4.47	5.48	-	-	-
	25	V	V		1.48	1.77	2.17	2.50	3.54	4.33	5.00	5.59	6.85	-	-	-
	30	V	V		1.77	2.12	2.60	3.00	4.24	5.20	6.00	6.71	8.22	-	-	-
	35	V	V		2.07	2.47	3.03	3.50	4.95	6.06	7.00	7.83	9.59	-	-	-
	40	V	V		2.37	2.83	3.46	4.00	5.66	6.93	8.00	8.94	10.95	-	-	-
	50		V	V	2.96	3.54	4.33	5.00	7.07	8.66	10.00	11.18	13.69	-	-	-
	60		V	V	3.55	4.24	5.20	6.00	8.49	10.39	12.00	13.42	16.43	-	-	-
	70		V	V	4.14	4.95	6.06	7.00	9.90	12.12	14.00	15.65	19.17	-	-	-
	80		V	V	4.73	5.66	6.93	8.00	11.31	13.86	16.00	17.89	21.91	-	-	-
	100			V	5.92	7.07	8.66	10.00	14.14	17.32	20.00	22.36	27.39	-	-	-
	120			V	7.10	8.49	10.39	12.00	16.97	20.78	24.00	26.83	32.86	-	-	-
	140			V	8.28	9.90	12.12	14.00	19.80	24.25	28.00	31.30	38.34	-	-	-

※ For MPa / bar / psi units, please refer to LORRIC.com.

KH Plastic clog-resistant full cone nozzle



【 Top view of nozzle spray pattern 】



【 Flow distribution 】

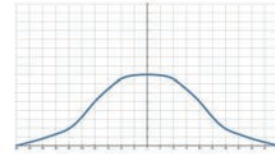

- Recommended working pressure: 2.0 kgf/cm²
- Flowrate tolerance: ± 10% @ 2.0 ± 0.1 kgf/cm²
- Angle tolerance: ± 10° @ 2.0 ± 0.1 kgf/cm²

Features

- Full cone spray.
- Unibody design allows for secure and easy installation, and X-shaped core provides minimal clogging.
- One piece body with removable core for easy cleaning and maintenance.

Applications

- Cleaning: Gas, exhaust gas, dust, cleaning device, tank cleaning, etc.
- Cooling: Gas, tank, machinery, metal, roof, etc.
- Dispersion: humidifying, chemicals, firefighting, dust suppression, aeration, defoaming, sewage treatment.

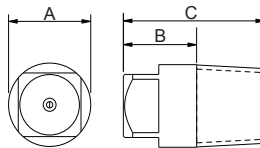

Appearance dimensions may vary depending on model, material. Please ask for details.

Material	Serie	Unit (mm)			Thread Type	Weight (g) PP
		A	B	C		
PP	1/8KH	12	10	19	1/8M	1.0
	1/4KH	15	11	21	1/4M	1.8
	3/8KH	16	13	25	3/8M	3.0

Material

- Body: PP
- CORE: PP

How to place an order for LORRIC nozzles?

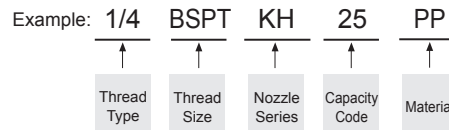

※ Standard Pressure: Column in red.
 ※ This product for spray angle 90° and 120° is able to be made to order.

Spray Angle	Capacity Code	Thread Size			Capacity at Pressure									Average particle size (um)	Min. Free Passage (mm)	Filter mesh										
		1/8	1/4	3/8	0.7 kgf/cm ²	1 kgf/cm ²	1.5 kgf/cm ²	2 kgf/cm ²	4 kgf/cm ²	6 kgf/cm ²	8 kgf/cm ²	10 kgf/cm ²	15 kgf/cm ²													
50°	10	V	V		0.59	0.71	0.87	1.00	1.41	1.73	2.00	2.24	2.74	230	0.7	100										
	15	V	V		0.89	1.06	1.30	1.50	2.12	2.60	3.00	3.35	4.11		}	1	-									
	20	V	V		1.18	1.41	1.73	2.00	2.83	3.46	4.00	4.47	5.48			270	1.3	-								
	25	V	V		1.48	1.77	2.17	2.50	3.54	4.33	5.00	5.59	6.85				}	1.4	-							
	30	V	V		1.77	2.12	2.60	3.00	4.24	5.20	6.00	6.71	8.22					}	1.5	-						
	35	V	V		2.07	2.47	3.03	3.50	4.95	6.06	7.00	7.83	9.59						}	1.6	-					
	40	V	V		2.37	2.83	3.46	4.00	5.66	6.93	8.00	8.94	10.95							}	1.7	-				
	50		V	V	2.96	3.54	4.33	5.00	7.07	8.66	10.00	11.18	13.69								400	1.7	-			
	60		V	V	3.55	4.24	5.20	6.00	8.49	10.39	12.00	13.42	16.43									}	1.7	-		
	70		V	V	4.14	4.95	6.06	7.00	9.90	12.12	14.00	15.65	19.17										}	1.9	-	
	80		V	V	4.73	5.66	6.93	8.00	11.31	13.86	16.00	17.89	21.91											}	1.9	-
	100			V	5.92	7.07	8.66	10.00	14.14	17.32	20.00	22.36	27.39												}	2
120			V	7.10	8.49	10.39	12.00	16.97	20.78	24.00	26.83	32.86	}	2.1												-
95°	140			V	8.28	9.90	12.12	14.00	19.80	24.25	28.00	31.30		38.34	640											2.5

※ For MPa / bar / psi units, please refer to LORRIC.com.

QSF

Plastic clog-resistant easy install full cone nozzle



【 Top view of nozzle spray pattern 】

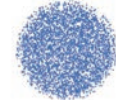

【 Flow distribution 】

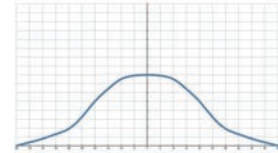

- Recommended working pressure: 2.0 kgf/cm²
- Flowrate tolerance: ± 10% @ 2.0 ± 0.1 kgf/cm²
- Angle tolerance: ± 10° @ 2.0 ± 0.1 kgf/cm²

Features

- Full cone spray.
- Unibody design allows for secure and easy installation, and X-shaped core provides minimal clogging. It is often used in etching and developing processes for semiconductors and printed circuit boards that require extremely high spray uniformity.
- Two piece nozzle design which includes nozzle and the body allows quick and accurate installation by hand. It is convenient for on-site management. Nozzle tip is secured into the body and fastened by three buckle points to avoid the nozzle tip loosening

and ensure the performance quality.

- The internal gaskets are available in various options such as EPDM, Viton and Viton-F, which can be adapted to various types of chemicals. With special structural design, the nozzles can be closely attached to the base to avoid water leakage.
- These general-purpose nozzles without guaranteed flow and angle tolerance are not recommended for environments with high accuracy requirements.

Applications

- Cleaning: Gas, exhaust gas, dust, cleaning device, tank cleaning, etc.
- Cooling: Gas, tank, machinery, metal, roof, etc.
- Dispersion: Humidifying, chemicals, dust suppression.

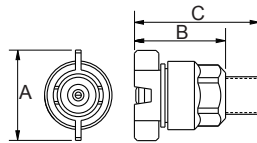

Appearance dimensions may vary depending on model, material. Please ask for details.

Material	Serie	Unit (mm)			Thread Type	Weight (g)
		A	B	C		
Plastic	1/4QSF	31	31	44	1/4M	10.4
	3/8QSF	31	31	44	3/8M	14.6

Material

- TIP: PP
- Core: PP
- Oring: EPDM, VITON, VITON F
- Body: PP, C-PVC

How to place an order for LORRIC nozzles?

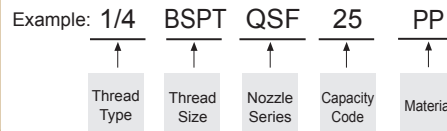

※ Standard Pressure: Column in red.
 ※ This product for spray angle 90° and 120° is able to be made to order.

Spray Angle	Capacity Code	Capacity at Pressure									Average particle size (um)	Min. Free Passage (mm)	Filter mesh
		0.7 kgf/cm ²	1 kgf/cm ²	1.5 kgf/cm ²	2 kgf/cm ²	4 kgf/cm ²	6 kgf/cm ²	8 kgf/cm ²	10 kgf/cm ²	15 kgf/cm ²			
50°	25	1.48	1.77	2.17	2.50	3.54	4.33	5.00	5.59	6.85	}	1.4	-
	30	1.77	2.12	2.60	3.00	4.24	5.20	6.00	6.71	8.22		1.5	-
	35	2.07	2.47	3.03	3.50	4.95	6.06	7.00	7.83	9.59		1.6	-
	40	2.37	2.83	3.46	4.00	5.66	6.93	8.00	8.94	10.95		1.7	-
	45	2.66	3.18	3.90	4.50	6.36	7.79	9.00	10.06	12.32	400	1.7	-
90°	50	2.96	3.54	4.33	5.00	7.07	8.66	10.00	11.18	13.69	}	1.7	-
	55	3.25	3.89	4.76	5.50	7.78	9.53	11.00	12.30	15.06		1.7	-

※ For MPa / bar / psi units, please refer to LORRIC.com.

QFF Plastic clog-resistant easy install full cone nozzle



【 Top view of nozzle spray pattern 】

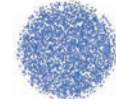

【 Flow distribution 】

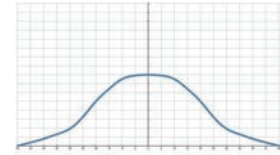

- Recommended working pressure: 2.0 kgf/cm²
- Flowrate tolerance: ± 5% @ 2.0 ± 0.1 kgf/cm²
- Angle tolerance: ± 5° @ 2.0 ± 0.1 kgf/cm²

Features

- Full cone spray.
- Unibody design allows for secure and easy installation, and X-shaped core provides minimal clogging. It is often used in etching and developing processes for semiconductors and printed circuit boards that require high spray uniformity.
- Two piece nozzle design which includes nozzle and the body allows quick and accurate installation by hand. It is convenient for on-site management. Nozzle tip is secured into the body and fastened by three buckle points to avoid the nozzle tip loosening

and ensure the performance quality.

- Internal gaskets are available in various options such as EPDM, Viton, and Viton-F, which can be adapted to various types of chemical processes. The special structural design allows the nozzles to closely contact the base to prevent water leakage.

Applications

- Cleaning: Gas, exhaust gas, dust, cleaning device, tank cleaning, etc.
- Cooling: Gas, tank, machinery, metal, roof, etc.
- Dispersion: Humidifying, chemicals, dust suppression.

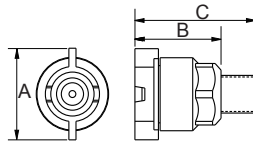

Appearance dimensions may vary depending on model, material. Please ask for details.

Material	Serie	Unit (mm)			Thread Type	Weight (g) PVDF
		A	B	C		
Plastic	1/8QFF	32	28	39	1/8M	17.5
	1/4QFF	32	28	43	1/4M	17.9
	3/8QFF	32	28	43	3/8M	19.6

Material

- TIP: PVDF
- Core: PP
- Oring: EPDM, VITON
- Body: PVDF, PP, U-PVC (QFSA, QFWG)

How to place an order for LORRIC nozzles?

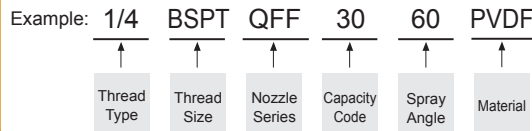

※ Standard Pressure: Column in red.
 ※ This product for spray angle 90° and 120° is able to be made to order.

Spray Angle	Capacity Code	Capacity at Pressure									Average particle size (um)	Min. Free Passage (mm)	Filter mesh	
		0.7 kgf/cm ²	1 kgf/cm ²	1.5 kgf/cm ²	2 kgf/cm ²	4 kgf/cm ²	6 kgf/cm ²	8 kgf/cm ²	10 kgf/cm ²	15 kgf/cm ²				
50°	10	0.59	0.71	0.87	1.00	1.41	1.73	2.00	2.24	2.74	}	0.7	100	
	15	0.89	1.06	1.30	1.50	2.12	2.60	3.00	3.35	4.11		1	-	
	20	1.18	1.41	1.73	2.00	2.83	3.46	4.00	4.47	5.48		270	1.3	-
	25	1.48	1.77	2.17	2.50	3.54	4.33	5.00	5.59	6.85		}	1.4	-
	30	1.77	2.12	2.60	3.00	4.24	5.20	6.00	6.71	8.22			1.5	-
	35	2.07	2.47	3.03	3.50	4.95	6.06	7.00	7.83	9.59			1.6	-
	40	2.37	2.83	3.46	4.00	5.66	6.93	8.00	8.94	10.95			400	1.7
	45	2.66	3.18	3.90	4.50	6.36	7.79	9.00	10.06	12.32		1.7		-
50	2.96	3.54	4.33	5.00	7.07	8.66	10.00	11.18	13.69	}	1.7	-		
90°	55	3.25	3.89	4.76	5.50	7.78	9.53	11.00	12.30		15.06	1.7	-	

※ For MPa / bar / psi units, please refer to LORRIC.com.

Spray Angle	Capacity Code	Capacity at Pressure									Average particle size (µm)	Min. Free Passage (mm)	Filter mesh
		0.7 kgf/cm ²	1 kgf/cm ²	1.5 kgf/cm ²	2 kgf/cm ²	4 kgf/cm ²	6 kgf/cm ²	8 kgf/cm ²	10 kgf/cm ²	15 kgf/cm ²			
90°	10	0.59	0.71	0.87	1.00	1.41	1.73	2.00	2.24	2.74	-	-	-
	15	0.89	1.06	1.30	1.50	2.12	2.60	3.00	3.35	4.11	-	-	-
	20	1.18	1.41	1.73	2.00	2.83	3.46	4.00	4.47	5.48	-	-	-
	25	1.48	1.77	2.17	2.50	3.54	4.33	5.00	5.59	6.85	-	-	-
	30	1.77	2.12	2.60	3.00	4.24	5.20	6.00	6.71	8.22	-	-	-
	35	2.07	2.47	3.03	3.50	4.95	6.06	7.00	7.83	9.59	-	-	-
	40	2.37	2.83	3.46	4.00	5.66	6.93	8.00	8.94	10.95	-	-	-
	45	2.66	3.18	3.90	4.50	6.36	7.79	9.00	10.06	12.32	-	-	-
	50	2.96	3.54	4.33	5.00	7.07	8.66	10.00	11.18	13.69	-	-	-
	55	3.25	3.89	4.76	5.50	7.78	9.53	11.00	12.30	15.06	-	-	-
120°	10	0.59	0.71	0.87	1.00	1.41	1.73	2.00	2.24	2.74	-	-	-
	15	0.89	1.06	1.30	1.50	2.12	2.60	3.00	3.35	4.11	-	-	-
	20	1.18	1.41	1.73	2.00	2.83	3.46	4.00	4.47	5.48	-	-	-
	25	1.48	1.77	2.17	2.50	3.54	4.33	5.00	5.59	6.85	-	-	-
	30	1.77	2.12	2.60	3.00	4.24	5.20	6.00	6.71	8.22	-	-	-
	35	2.07	2.47	3.03	3.50	4.95	6.06	7.00	7.83	9.59	-	-	-
	40	2.37	2.83	3.46	4.00	5.66	6.93	8.00	8.94	10.95	-	-	-
	45	2.66	3.18	3.90	4.50	6.36	7.79	9.00	10.06	12.32	-	-	-
	50	2.96	3.54	4.33	5.00	7.07	8.66	10.00	11.18	13.69	-	-	-
	55	3.25	3.89	4.76	5.50	7.78	9.53	11.00	12.30	15.06	-	-	-

※ For MPa / bar / psi units, please refer to LORRIC.com.

QFMF Plastic easy install full cone nozzle for precise distribution



【 Top view of nozzle spray pattern 】



【 Flow distribution 】

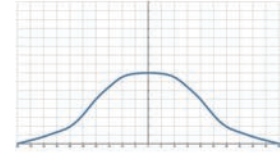

- Recommended working pressure: 2.0 kgf/cm²
- Flowrate tolerance: ± 5% @ 2.0 ± 0.1 kgf/cm²
- Angle tolerance: ± 5° @ 2.0 ± 0.1 kgf/cm²

Full Cone Nozzles

Features

- Full cone spray.
- Adopts a Holeless multi-slotted core, possess a more uniform impact than other standard solid cone nozzles of the same type.
- Two piece nozzle design which includes nozzle and the body allows quick and accurate installation by hand. It is convenient for on-site management. Nozzle tip is secured into the body and fastened by three buckle points to avoid the nozzle tip loosening

and ensure the performance quality.

- The internal gaskets are available in various options such as EPDM, Viton and Viton-F, which can be adapted to various types of chemicals. With special structural design, the nozzles can be closely attached to the base to avoid water leakage.

Applications

- Cleaning: Gas, exhaust gas, dust, cleaning device, tank cleaning, etc.
- Cooling: Gas, tank, machinery, metal, roof, etc.
- Dispersion: Humidifying, Dust Suppression.

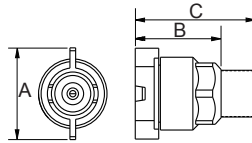

Appearance dimensions may vary depending on model, material. Please ask for details.

Material	Serie	Unit (mm)			Thread Type	Weight (g) PVDF
		A	B	C		
PVDF	1/8QFMF	32	28	39	1/8M	17.2
	1/4QFMF	32	28	43	1/4M	17.6
	3/8QFMF	32	28	43	3/8M	19.3

Material

- TIP: PVDF
- Core: U-PVC, PEEK
- Oring: EPDM, VITON
- Body: PVDF, PP, U-PVC (QFSA, QFWG)

How to place an order for LORRIC nozzles?

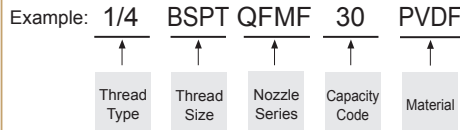

※ Standard Pressure: Column in red.
 ※ This product for spray angle 90° and 120° is able to be made to order.

Spray Angle	Capacity Code	Capacity at Pressure									Average particle size (um)	Min. Free Passage (mm)	Filter mesh		
		0.7 kgf/cm ²	1 kgf/cm ²	1.5 kgf/cm ²	2 kgf/cm ²	4 kgf/cm ²	6 kgf/cm ²	8 kgf/cm ²	10 kgf/cm ²	15 kgf/cm ²					
50°	10	0.59	0.71	0.87	1.00	1.41	1.73	2.00	2.24	2.74	230	0.5	100		
	15	0.89	1.06	1.30	1.50	2.12	2.60	3.00	3.35	4.11		270	0.8	50	
	20	1.18	1.41	1.73	2.00	2.83	3.46	4.00	4.47	5.48			400	1.1	-
	25	1.48	1.77	2.17	2.50	3.54	4.33	5.00	5.59	6.85				1.2	-
	}	30	1.77	2.12	2.60	3.00	4.24	5.20	6.00	6.71	8.22				1.3
		35	2.07	2.47	3.03	3.50	4.95	6.06	7.00	7.83	9.59	1.4			
		40	2.37	2.83	3.46	4.00	5.66	6.93	8.00	8.94	10.95		1.5		
	45	2.66	3.18	3.90	4.50	6.36	7.79	9.00	10.06	12.32	1.5	-			
90°	50	2.96	3.54	4.33	5.00	7.07	8.66	10.00	11.18	13.69		1.5	-		
	55	3.25	3.89	4.76	5.50	7.78	9.53	11.00	12.30	15.06	1.5		-		

※ For MPa / bar / psi units, please refer to LORRIC.com.

Spray Angle	Capacity Code	Capacity at Pressure									Average particle size (um)	Min. Free Passage (mm)	Filter mesh
		0.7 kgf/cm ²	1 kgf/cm ²	1.5 kgf/cm ²	2 kgf/cm ²	4 kgf/cm ²	6 kgf/cm ²	8 kgf/cm ²	10 kgf/cm ²	15 kgf/cm ²			
90°	10	0.59	0.71	0.87	1.00	1.41	1.73	2.00	2.24	2.74	-	-	-
	15	0.89	1.06	1.30	1.50	2.12	2.60	3.00	3.35	4.11	-	-	-
	20	1.18	1.41	1.73	2.00	2.83	3.46	4.00	4.47	5.48	-	-	-
	25	1.48	1.77	2.17	2.50	3.54	4.33	5.00	5.59	6.85	-	-	-
	30	1.77	2.12	2.60	3.00	4.24	5.20	6.00	6.71	8.22	-	-	-
	35	2.07	2.47	3.03	3.50	4.95	6.06	7.00	7.83	9.59	-	-	-
	40	2.37	2.83	3.46	4.00	5.66	6.93	8.00	8.94	10.95	-	-	-
	45	2.66	3.18	3.90	4.50	6.36	7.79	9.00	10.06	12.32	-	-	-
	50	2.96	3.54	4.33	5.00	7.07	8.66	10.00	11.18	13.69	-	-	-
	55	3.25	3.89	4.76	5.50	7.78	9.53	11.00	12.30	15.06	-	-	-
120°	10	0.59	0.71	0.87	1.00	1.41	1.73	2.00	2.24	2.74	-	-	-
	15	0.89	1.06	1.30	1.50	2.12	2.60	3.00	3.35	4.11	-	-	-
	20	1.18	1.41	1.73	2.00	2.83	3.46	4.00	4.47	5.48	-	-	-
	25	1.48	1.77	2.17	2.50	3.54	4.33	5.00	5.59	6.85	-	-	-
	30	1.77	2.12	2.60	3.00	4.24	5.20	6.00	6.71	8.22	-	-	-
	35	2.07	2.47	3.03	3.50	4.95	6.06	7.00	7.83	9.59	-	-	-
	40	2.37	2.83	3.46	4.00	5.66	6.93	8.00	8.94	10.95	-	-	-
	45	2.66	3.18	3.90	4.50	6.36	7.79	9.00	10.06	12.32	-	-	-
	50	2.96	3.54	4.33	5.00	7.07	8.66	10.00	11.18	13.69	-	-	-
	55	3.25	3.89	4.76	5.50	7.78	9.53	11.00	12.30	15.06	-	-	-

※ For MPa / bar / psi units, please refer to LORRIC.com.

QFYF Plastic clog-resistant easy install full cone nozzle



【 Top view of nozzle spray pattern 】

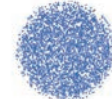

【 Flow distribution 】

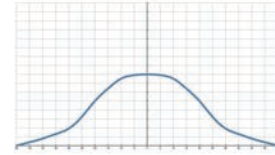

- Recommended working pressure: 2.0 kgf/cm²
- Flowrate tolerance: ± 5% @ 2.0 ± 0.1 kgf/cm²
- Angle tolerance: ± 5° @ 2.0 ± 0.1 kgf/cm²

Full Cone Nozzles

Features

- Full cone spray.
- Unibody design allows for secure and easy installation, and X-shaped core provides minimal clogging. It is often used in etching and developing processes for semiconductors and printed circuit boards that require extremely high spray uniformity.
- Two piece nozzle design which includes nozzle and the body allows quick and accurate installation by hand. It is convenient for on-site management. Nozzle tip is secured into the body and fastened by three buckle points to avoid the nozzle tip loosening

and ensure the performance quality.

- Internal gaskets are available in various options such as EPDM, Viton, and Viton-F, which can be adapted to various types of chemical processes. The special structural design allows the nozzles to closely contact the base to prevent water leakage.
- Y-shaped rotary handle design leads to easier dismantling.

Applications

- Cleaning: Gas, exhaust gas, dust, cleaning device, tank cleaning, etc.
- Cooling: Gas, tank, machinery, metal, roof, etc.
- Dispersion: Humidifying, chemicals, dust suppression

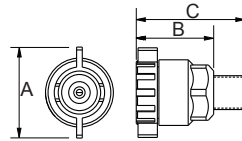

Appearance dimensions may vary depending on model, material. Please ask for details.

Material	Serie	Unit (mm)			Thread Type	Weight (g)	
		A	B	C		PP	PVDF
Plastic	1/8QFYF	35	28	39	1/8M	10.7	18.7
	1/4QFYF	35	28	43	1/4M	10.9	19.1
	3/8QFYF	35	28	43	3/8M	11.9	20.8

Material

- TIP: PP, PVDF
- Core: PP
- Oring: EPDM, VITON
- Body: PVDF, PP, U-PVC (QFSA, QFWG)

How to place an order for LORRIC nozzles?

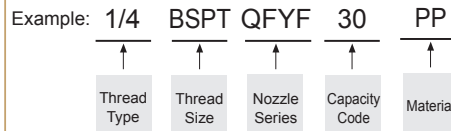

※ Standard Pressure: Column in red.
 ※ This product for spray angle 90° and 120° is able to be made to order.

Spray Angle	Capacity Code	Capacity at Pressure									Average particle size (um)	Min. Free Passage (mm)	Filter mesh	
		0.7 kgf/cm ²	1 kgf/cm ²	1.5 kgf/cm ²	2 kgf/cm ²	4 kgf/cm ²	6 kgf/cm ²	8 kgf/cm ²	10 kgf/cm ²	15 kgf/cm ²				
50°	10	0.59	0.71	0.87	1.00	1.41	1.73	2.00	2.24	2.74	230	0.7	100	
	15	0.89	1.06	1.30	1.50	2.12	2.60	3.00	3.35	4.11		1	-	
	20	1.18	1.41	1.73	2.00	2.83	3.46	4.00	4.47	5.48		270	1.3	-
	25	1.48	1.77	2.17	2.50	3.54	4.33	5.00	5.59	6.85		400	1.4	-
	30	1.77	2.12	2.60	3.00	4.24	5.20	6.00	6.71	8.22			1.5	-
	35	2.07	2.47	3.03	3.50	4.95	6.06	7.00	7.83	9.59			1.6	-
	40	2.37	2.83	3.46	4.00	5.66	6.93	8.00	8.94	10.95			1.7	-
	45	2.66	3.18	3.90	4.50	6.36	7.79	9.00	10.06	12.32		400	1.7	-
50	2.96	3.54	4.33	5.00	7.07	8.66	10.00	11.18	13.69	1.7	-			
90°	55	3.25	3.89	4.76	5.50	7.78	9.53	11.00	12.30	15.06	400	1.7	-	

※ For MPa / bar / psi units, please refer to LORRIC.com.

Spray Angle	Capacity Code	Capacity at Pressure									Average particle size (um)	Min. Free Passage (mm)	Filter mesh
		0.7 kgf/cm ²	1 kgf/cm ²	1.5 kgf/cm ²	2 kgf/cm ²	4 kgf/cm ²	6 kgf/cm ²	8 kgf/cm ²	10 kgf/cm ²	15 kgf/cm ²			
90°	10	0.59	0.71	0.87	1.00	1.41	1.73	2.00	2.24	2.74	-	-	-
	15	0.89	1.06	1.30	1.50	2.12	2.60	3.00	3.35	4.11	-	-	-
	20	1.18	1.41	1.73	2.00	2.83	3.46	4.00	4.47	5.48	-	-	-
	25	1.48	1.77	2.17	2.50	3.54	4.33	5.00	5.59	6.85	-	-	-
	30	1.77	2.12	2.60	3.00	4.24	5.20	6.00	6.71	8.22	-	-	-
	35	2.07	2.47	3.03	3.50	4.95	6.06	7.00	7.83	9.59	-	-	-
	40	2.37	2.83	3.46	4.00	5.66	6.93	8.00	8.94	10.95	-	-	-
	45	2.66	3.18	3.90	4.50	6.36	7.79	9.00	10.06	12.32	-	-	-
	50	2.96	3.54	4.33	5.00	7.07	8.66	10.00	11.18	13.69	-	-	-
55	3.25	3.89	4.76	5.50	7.78	9.53	11.00	12.30	15.06	-	-	-	
120°	10	0.59	0.71	0.87	1.00	1.41	1.73	2.00	2.24	2.74	-	-	-
	15	0.89	1.06	1.30	1.50	2.12	2.60	3.00	3.35	4.11	-	-	-
	20	1.18	1.41	1.73	2.00	2.83	3.46	4.00	4.47	5.48	-	-	-
	25	1.48	1.77	2.17	2.50	3.54	4.33	5.00	5.59	6.85	-	-	-
	30	1.77	2.12	2.60	3.00	4.24	5.20	6.00	6.71	8.22	-	-	-
	35	2.07	2.47	3.03	3.50	4.95	6.06	7.00	7.83	9.59	-	-	-
	40	2.37	2.83	3.46	4.00	5.66	6.93	8.00	8.94	10.95	-	-	-
	45	2.66	3.18	3.90	4.50	6.36	7.79	9.00	10.06	12.32	-	-	-
	50	2.96	3.54	4.33	5.00	7.07	8.66	10.00	11.18	13.69	-	-	-
55	3.25	3.89	4.76	5.50	7.78	9.53	11.00	12.30	15.06	-	-	-	

※ For MPa / bar / psi units, please refer to LORRIC.com.

QFYMF Plastic easy install full cone nozzle for precise distribution



- Recommended working pressure: 2.0 kgf/cm²
- Flowrate tolerance: ± 5% @ 2.0 ± 0.1 kgf/cm²
- Angle tolerance: ± 5° @ 2.0 ± 0.1 kgf/cm²

【 Top view of nozzle spray pattern 】

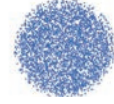

【 Flow distribution 】

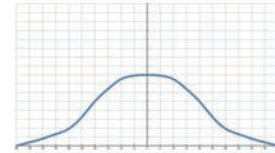

Full Cone Nozzles

Features

- Full cone spray.
- Adopts a holeless multi-slotted core, possessing a more uniform impact than other standard solid cone nozzles of the same type. It is often used in semiconductor and printed circuit board etching and developing processes where spraying uniformity is extremely demanding.
- Two piece nozzle design which includes nozzle and the body allows quick and accurate installation by hand. It is convenient for on-site management. Nozzle tip is secured into the body and fastened by three buckle points to avoid the nozzle tip loosening

and ensure the performance quality.

- Internal gaskets are available in various options such as EPDM, Viton, and Viton-F, which can be adapted to various types of chemical processes. The special structural design allows the nozzles to closely contact the base to prevent water leakage.

- Y-shaped rotary handle design leads to easier dismantling.

Applications

- Cleaning: Gas, exhaust gas, dust, cleaning device, tank cleaning, etc.
- Cooling: Gas, tank, machinery, metal, roof, etc.
- Dispersion: Humidifying, chemicals, dust suppression.

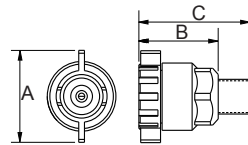

Appearance dimensions may vary depending on model, material. Please ask for details.

Material	Serie	Unit (mm)			Thread Type	Weight (g)	
		A	B	C		PP	PVDF
Plastic	1/8QFYMF	35	28	39	1/8M	10.7	18.7
	1/4QFYMF	35	28	43	1/4M	10.9	19.1
	3/8QFYMF	35	28	43	3/8M	11.9	20.8

Material

- TIP: PP, PVDF
- Core: U-PVC, PEEK
- Oring: EPDM, VITON
- Body: PVDF, PP, U-PVC(QFSA, QFWG)

How to place an order for LORRIC nozzles?

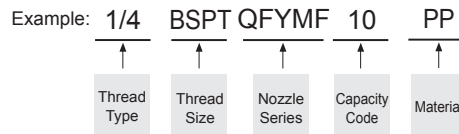

※ Standard Pressure: Column in red.
 ※ This product for spray angle 90° and 120° is able to be made to order.

Spray Angle	Capacity Code	Capacity at Pressure									Average particle size (um)	Min. Free Passage (mm)	Filter mesh						
		0.7 kgf/cm ²	1 kgf/cm ²	1.5 kgf/cm ²	2 kgf/cm ²	4 kgf/cm ²	6 kgf/cm ²	8 kgf/cm ²	10 kgf/cm ²	15 kgf/cm ²									
50°	10	0.59	0.71	0.87	1.00	1.41	1.73	2.00	2.24	2.74	230	0.5	100						
	15	0.89	1.06	1.30	1.50	2.12	2.60	3.00	3.35	4.11		}	0.8	50					
	20	1.18	1.41	1.73	2.00	2.83	3.46	4.00	4.47	5.48			}	1.1	-				
	25	1.48	1.77	2.17	2.50	3.54	4.33	5.00	5.59	6.85				}	1.2	-			
	30	1.77	2.12	2.60	3.00	4.24	5.20	6.00	6.71	8.22					}	1.3	-		
	35	2.07	2.47	3.03	3.50	4.95	6.06	7.00	7.83	9.59						}	1.4	-	
	40	2.37	2.83	3.46	4.00	5.66	6.93	8.00	8.94	10.95							}	1.5	-
	45	2.66	3.18	3.90	4.50	6.36	7.79	9.00	10.06	12.32								}	1.5
90°	50	2.96	3.54	4.33	5.00	7.07	8.66	10.00	11.18	13.69	}								1.5
	55	3.25	3.89	4.76	5.50	7.78	9.53	11.00	12.30	15.06		}							1.5

※ For MPa / bar / psi units, please refer to LORRIC.com.

Spray Angle	Capacity Code	Capacity at Pressure									Average particle size (um)	Min. Free Passage (mm)	Filter mesh
		0.7 kgf/cm ²	1 kgf/cm ²	1.5 kgf/cm ²	2 kgf/cm ²	4 kgf/cm ²	6 kgf/cm ²	8 kgf/cm ²	10 kgf/cm ²	15 kgf/cm ²			
90°	10	0.59	0.71	0.87	1.00	1.41	1.73	2.00	2.24	2.74	-	-	-
	15	0.89	1.06	1.30	1.50	2.12	2.60	3.00	3.35	4.11	-	-	-
	20	1.18	1.41	1.73	2.00	2.83	3.46	4.00	4.47	5.48	-	-	-
	25	1.48	1.77	2.17	2.50	3.54	4.33	5.00	5.59	6.85	-	-	-
	30	1.77	2.12	2.60	3.00	4.24	5.20	6.00	6.71	8.22	-	-	-
	35	2.07	2.47	3.03	3.50	4.95	6.06	7.00	7.83	9.59	-	-	-
	40	2.37	2.83	3.46	4.00	5.66	6.93	8.00	8.94	10.95	-	-	-
	45	2.66	3.18	3.90	4.50	6.36	7.79	9.00	10.06	12.32	-	-	-
	50	2.96	3.54	4.33	5.00	7.07	8.66	10.00	11.18	13.69	-	-	-
	55	3.25	3.89	4.76	5.50	7.78	9.53	11.00	12.30	15.06	-	-	-
120°	10	0.59	0.71	0.87	1.00	1.41	1.73	2.00	2.24	2.74	-	-	-
	15	0.89	1.06	1.30	1.50	2.12	2.60	3.00	3.35	4.11	-	-	-
	20	1.18	1.41	1.73	2.00	2.83	3.46	4.00	4.47	5.48	-	-	-
	25	1.48	1.77	2.17	2.50	3.54	4.33	5.00	5.59	6.85	-	-	-
	30	1.77	2.12	2.60	3.00	4.24	5.20	6.00	6.71	8.22	-	-	-
	35	2.07	2.47	3.03	3.50	4.95	6.06	7.00	7.83	9.59	-	-	-
	40	2.37	2.83	3.46	4.00	5.66	6.93	8.00	8.94	10.95	-	-	-
	45	2.66	3.18	3.90	4.50	6.36	7.79	9.00	10.06	12.32	-	-	-
	50	2.96	3.54	4.33	5.00	7.07	8.66	10.00	11.18	13.69	-	-	-
	55	3.25	3.89	4.76	5.50	7.78	9.53	11.00	12.30	15.06	-	-	-

※ For MPa / bar / psi units, please refer to LORRIC.com.

QT Plastic full cone nozzle with pipe clamp



【 Top view of nozzle spray pattern 】

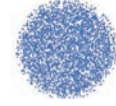

【 Flow distribution 】

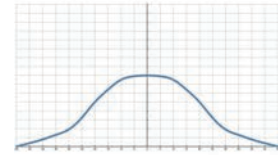

- Recommended working pressure: 2.0 kgf/cm²
- Flowrate tolerance: ± 10% @ 2.0 ± 0.1 kgf/cm²
- Angle tolerance: ± 10° @ 2.0 ± 0.1 kgf/cm²
- Size:
 - Drilling hole size: Ø 20 (19.0~20m/m)
 - Fits pipe size: 1-1/4, 1-1/2O

Features

- Full cone spray.
- The two-piece combination design is divided into a nozzle and a body. The nozzle part can be fixed to the body without fixing the nut. The body has a special pipe clamp design. It is only necessary to drill a hole in the water outlet pipe, and then lock it with iron screw. The nozzle is fixed on the pipe. This nozzle is commonly used in the pre-painting and continuous casting machine cooling process.
- Size:
 - Drilling hole size for pipe clamp: Ø 20 (19.0~20m/m)
 - Fits pipe size: 1-1/4"(OD42 +/-0.3mm), 1-1/2"(OD48 +/-0.4mm)

Applications

- Cleaning: Dust, cleaning device, etc.
- Dispersion: Humidifying, fire fighting, and dust suppression.

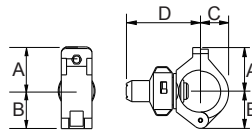

Material	Serie	Unit (mm)				Thread Type	Weight (g) PP
		A	B	C	D		
Plastic	1-1/4QT	42	50	31	85	1-1/4M	105.4
	1-1/2QT	42	50	31	85	1-1/2M	100.5

Appearance dimensions may vary depending on model, material. Please ask for details.

Material

- Nozzle: PP
- QT Body: FRPP
- Oring: NBR

How to place an order for LORRIC nozzles?

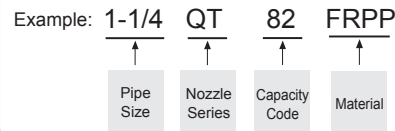

※ Standard Pressure: Column in red.
 ※ This product for spray angle 90° and 120° is able to be made to order.

Spray Angle	Capacity Code	Thread Size		Capacity at Pressure									Average particle size (um)	Min. Free Passage (mm)	Filter mesh
		1-1/4	1-1/2	0.5 kgf/cm ²	1 kgf/cm ²	1.5 kgf/cm ²	2 kgf/cm ²	2.5 kgf/cm ²	3 kgf/cm ²	3.5 kgf/cm ²	4 kgf/cm ²	5 kgf/cm ²			
60°	82	v	v	15.0	21.2	26.0	30.0	33.5	36.7	39.7	42.4	47.4	700	3.2	-

※ For MPa / bar / psi units, please refer to LORRIC.com.

KDMF Plastic full cone nozzle



- Recommended working pressure: 2.0 kgf/cm²
- Flowrate tolerance: ± 5% @ 2.0 ± 0.1 kgf/cm²
- Angle tolerance: ± 5° @ 2.0 ± 0.1 kgf/cm²

【 Top view of nozzle spray pattern 】



【 Flow distribution 】

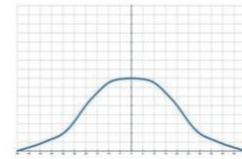

Features

- Full cone spray.
- Adopts a holeless multi-slotted core, possessing a more uniform impact than other standard solid cone nozzles of the same type. It is often used in semiconductor and printed circuit board etching and developing processes where spraying uniformity is extremely demanding.
- Two piece nozzle design allows for quick and accurate installation by hand.

Applications

- Cleaning: Gas, exhaust gas, dust, cleaning device, tank cleaning, etc.
- Cooling: Conveyor belts, gas, tank, machinery, metal, roof, etc.
- Dispersion: Humidifying, chemicals, dust suppression.

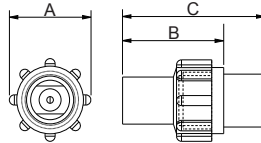

Appearance dimensions may vary depending on model, material. Please ask for details.

Material	Serie	Unit (mm)					Thread Type	Weight (g)
		A	B	C	D	E		
Plastic	KDMF	31	18	16	55	20	-	25

Material

- Nozzle: PVDF
- Body: UPVC

How to place an order for LORRIC nozzles?

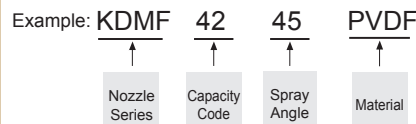

※ Standard Pressure: Column in red.
 ※ This product for spray angle 90° and 120° is able to be made to order.

Spray Angle	Capacity Code	Capacity at Pressure									Average particle size (um)	Min. Free Passage (mm)	Filter mesh
		0.7 kgf/cm ²	1 kgf/cm ²	1.5 kgf/cm ²	2 kgf/cm ²	4 kgf/cm ²	6 kgf/cm ²	8 kgf/cm ²	10 kgf/cm ²	15 kgf/cm ²			
45°	42	2.48	2.97	3.64	4.20	5.94	7.27	8.40	9.39	11.50	-	1.5	-
58°	13	3.14	3.75	4.59	5.30	7.50	9.18	10.60	11.85	14.51	420	1.5	-
45°	65	3.85	4.60	5.63	6.50	9.19	11.26	13.00	14.53	17.80	-	1.5	-

※ For MPa / bar / psi units, please refer to LORRIC.com.

KPMF M Metal full cone nozzle for precise distribution



- Recommended working pressure: 2.0 kgf/cm²
- Flowrate tolerance: ± 5% @ 2.0 ± 0.1 kgf/cm²
- Angle tolerance: ± 5° @ 2.0 ± 0.1 kgf/cm²

【Top view of nozzle spray pattern】



【Flow distribution】

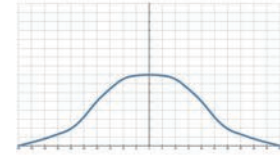

Features

- Full cone spray.
- Adopts a Holeless multi-slotted core, possess a more uniform impact than other standard solid cone nozzles of the same type.

Applications

- Cleaning: Gas, exhaust gas, dust, cleaning device, tank cleaning, etc.
- Cooling: Gas, tank, machinery, metal, etc.
- Dispersion: Humidifying, chemicals, firefighting, dust suppression, aeration, defoaming, sewage treatment.

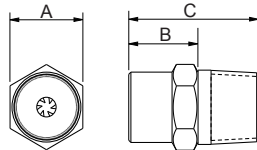

Material	Serie	Unit (mm)			Thread Type	Weight (g)		
		A	B	C		S303	S316	Brass
Metal	1/8KPMF(M)	12	12	19	1/8M	10	10.3	11.2
	1/4KPMF(M)	14	15	26	1/4M	20	20	19
	3/8KPMF(M)	18	15	30	3/8M	33	34	37

Appearance dimensions may vary depending on model, material. Please ask for details.

Material

- Metal: Stainless 303, Stainless 316, BRASS

How to place an order for LORRIC nozzles?

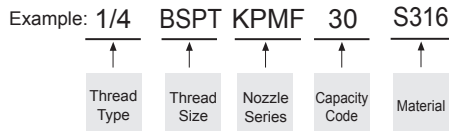

※ Standard Pressure: Column in red.
 ※ This product for spray angle 90° and 120° is able to be made to order.

Spray Angle	Capacity Code	Thread Size			Capacity at Pressure									Average particle size (um)	Min. Free Passage (mm)	Filter mesh	
		1/8	1/4	3/8	0.7 kgf/cm ²	1 kgf/cm ²	1.5 kgf/cm ²	2 kgf/cm ²	4 kgf/cm ²	6 kgf/cm ²	8 kgf/cm ²	10 kgf/cm ²	15 kgf/cm ²				
60°	10	V	V		0.59	0.71	0.87	1.00	1.41	1.73	2.00	2.24	2.74	230	0.5	100	
	15	V	V		0.89	1.06	1.30	1.50	2.12	2.60	3.00	3.35	4.11		270	0.8	50
	20	V	V		1.18	1.41	1.73	2.00	2.83	3.46	4.00	4.47	5.48			400	1.1
	25	V	V		1.48	1.77	2.17	2.50	3.54	4.33	5.00	5.59	6.85	400			1.2
	30	V	V		1.77	2.12	2.60	3.00	4.24	5.20	6.00	6.71	8.22		400		1.3
	35	V	V		2.07	2.47	3.03	3.50	4.95	6.06	7.00	7.83	9.59			400	1.4
	40	V	V		2.37	2.83	3.46	4.00	5.66	6.93	8.00	8.94	10.95	400			1.5
	50		V	V	2.96	3.54	4.33	5.00	7.07	8.66	10.00	11.18	13.69		400		1.5
	60		V	V	3.55	4.24	5.20	6.00	8.49	10.39	12.00	13.42	16.43			400	1.5
	70		V	V	4.14	4.95	6.06	7.00	9.90	12.12	14.00	15.65	19.17	400			1.7
	80		V	V	4.73	5.66	6.93	8.00	11.31	13.86	16.00	17.89	21.91		400		1.7
	100			V	5.92	7.07	8.66	10.00	14.14	17.32	20.00	22.36	27.39			400	1.8
120			V	7.10	8.49	10.39	12.00	16.97	20.78	24.00	26.83	32.86	400	1.9			-
90°	140			V	8.28	9.90	12.12	14.00	19.80	24.25	28.00	31.30		38.34	640		2.3

※ For MPa / bar / psi units, please refer to LORRIC.com.

Spray Angle	Capacity Code	Thread Size			Capacity at Pressure									Average particle size (um)	Min. Free Passage (mm)	Filter mesh
		1/8	1/4	3/8	0.7 kgf/cm ²	1 kgf/cm ²	1.5 kgf/cm ²	2 kgf/cm ²	4 kgf/cm ²	6 kgf/cm ²	8 kgf/cm ²	10 kgf/cm ²	15 kgf/cm ²			
90°	10	V	V		0.59	0.71	0.87	1.00	1.41	1.73	2.00	2.24	2.74	-	-	-
	15	V	V		0.89	1.06	1.30	1.50	2.12	2.60	3.00	3.35	4.11	-	-	-
	20	V	V		1.18	1.41	1.73	2.00	2.83	3.46	4.00	4.47	5.48	-	-	-
	25	V	V		1.48	1.77	2.17	2.50	3.54	4.33	5.00	5.59	6.85	-	-	-
	30	V	V		1.77	2.12	2.60	3.00	4.24	5.20	6.00	6.71	8.22	-	-	-
	35	V	V		2.07	2.47	3.03	3.50	4.95	6.06	7.00	7.83	9.59	-	-	-
	40	V	V		2.37	2.83	3.46	4.00	5.66	6.93	8.00	8.94	10.95	-	-	-
	50		V	V	2.96	3.54	4.33	5.00	7.07	8.66	10.00	11.18	13.69	-	-	-
	60		V	V	3.55	4.24	5.20	6.00	8.49	10.39	12.00	13.42	16.43	-	-	-
	70		V	V	4.14	4.95	6.06	7.00	9.90	12.12	14.00	15.65	19.17	-	-	-
	80		V	V	4.73	5.66	6.93	8.00	11.31	13.86	16.00	17.89	21.91	-	-	-
	100			V	5.92	7.07	8.66	10.00	14.14	17.32	20.00	22.36	27.39	-	-	-
	120			V	7.10	8.49	10.39	12.00	16.97	20.78	24.00	26.83	32.86	-	-	-
	140			V	8.28	9.90	12.12	14.00	19.80	24.25	28.00	31.30	38.34	-	-	-
120°	10	V	V		0.59	0.71	0.87	1.00	1.41	1.73	2.00	2.24	2.74	-	-	-
	15	V	V		0.89	1.06	1.30	1.50	2.12	2.60	3.00	3.35	4.11	-	-	-
	20	V	V		1.18	1.41	1.73	2.00	2.83	3.46	4.00	4.47	5.48	-	-	-
	25	V	V		1.48	1.77	2.17	2.50	3.54	4.33	5.00	5.59	6.85	-	-	-
	30	V	V		1.77	2.12	2.60	3.00	4.24	5.20	6.00	6.71	8.22	-	-	-
	35	V	V		2.07	2.47	3.03	3.50	4.95	6.06	7.00	7.83	9.59	-	-	-
	40	V	V		2.37	2.83	3.46	4.00	5.66	6.93	8.00	8.94	10.95	-	-	-
	50		V	V	2.96	3.54	4.33	5.00	7.07	8.66	10.00	11.18	13.69	-	-	-
	60		V	V	3.55	4.24	5.20	6.00	8.49	10.39	12.00	13.42	16.43	-	-	-
	70		V	V	4.14	4.95	6.06	7.00	9.90	12.12	14.00	15.65	19.17	-	-	-
	80		V	V	4.73	5.66	6.93	8.00	11.31	13.86	16.00	17.89	21.91	-	-	-
	100			V	5.92	7.07	8.66	10.00	14.14	17.32	20.00	22.36	27.39	-	-	-
	120			V	7.10	8.49	10.39	12.00	16.97	20.78	24.00	26.83	32.86	-	-	-
	140			V	8.28	9.90	12.12	14.00	19.80	24.25	28.00	31.30	38.34	-	-	-

※ For MPa / bar / psi units, please refer to LORRIC.com.

KPMF P Plastic full cone nozzle for precise distribution



【 Top view of nozzle spray pattern 】

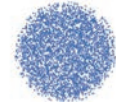

【 Flow distribution 】

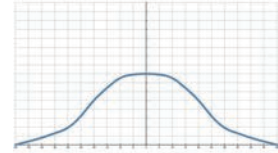

- Recommended working pressure: 2.0 kgf/cm²
- Flowrate tolerance: ± 5% @ 2.0 ± 0.1 kgf/cm²
- Angle tolerance: ± 5° @ 2.0 ± 0.1 kgf/cm²

Features

- Full cone spray.
- Adopts a Holeless multi-slotted core, possess a more uniform impact than other standard solid cone nozzles of the same type. Due to the high spray uniformity, chemical dispersion processes commonly used in semiconductors and printed circuit boards, such as etching processes.
- PVDF is resistant to temperature and corrosive chemical solutions.

Applications

- Cleaning: Gas, exhaust gas, dust, cleaning device, tank cleaning, etc.
- Cooling: Gas, tank, machinery, metal, etc.
- Dispersion: Humidifying, Chemicals, Firefighting, Dust suppression, Deodorization, Defoaming, Sewage treatment, etc.

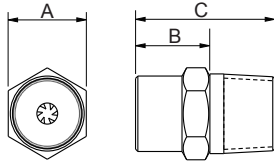

Appearance dimensions may vary depending on model, material. Please ask for details.

Material	Serie	Unit (mm)			Thread Type	Weight (g) PVDF
		A	B	C		
Plastic	1/8KPMF (P)	12	10	19	1/8M	1.5
	1/4KPMF (P)	15	11	21	1/4M	3.8
	3/8KPMF (P)	17	13	25	3/8M	6

Material

- Plastic: PVDF
- CORE: U-PVC, PEEK

How to place an order for LORRIC nozzles?

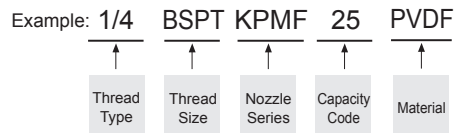

※ Standard Pressure: Column in red.
 ※ This product for spray angle 90° and 120° is able to be made to order.

Spray Angle	Capacity Code	Thread Size			Capacity at Pressure									Average particle size (um)	Min. Free Passage (mm)	Filter mesh				
		1/8	1/4	3/8	0.7 kgf/cm ²	1 kgf/cm ²	1.5 kgf/cm ²	2 kgf/cm ²	4 kgf/cm ²	6 kgf/cm ²	8 kgf/cm ²	10 kgf/cm ²	15 kgf/cm ²							
60°	10	V	V		0.59	0.71	0.87	1.00	1.41	1.73	2.00	2.24	2.74	230	0.5	100				
	15	V	V		0.89	1.06	1.30	1.50	2.12	2.60	3.00	3.35	4.11		270	0.8	50			
	20	V	V		1.18	1.41	1.73	2.00	2.83	3.46	4.00	4.47	5.48			400	1.1	-		
	25	V	V		1.48	1.77	2.17	2.50	3.54	4.33	5.00	5.59	6.85				400	1.2	-	
	30	V	V		1.77	2.12	2.60	3.00	4.24	5.20	6.00	6.71	8.22					400	1.3	-
	35	V	V		2.07	2.47	3.03	3.50	4.95	6.06	7.00	7.83	9.59						400	1.4
	40	V	V		2.37	2.83	3.46	4.00	5.66	6.93	8.00	8.94	10.95	400						1.5
	50		V	V	2.96	3.54	4.33	5.00	7.07	8.66	10.00	11.18	13.69		400					1.5
	60		V	V	3.55	4.24	5.20	6.00	8.49	10.39	12.00	13.42	16.43			400				1.5
	70		V	V	4.14	4.95	6.06	7.00	9.90	12.12	14.00	15.65	19.17				400			1.7
	80		V	V	4.73	5.66	6.93	8.00	11.31	13.86	16.00	17.89	21.91					400		1.7
	90°			V	5.92	7.07	8.66	10.00	14.14	17.32	20.00	22.36	27.39						400	1.8
			V	7.10	8.49	10.39	12.00	16.97	20.78	24.00	26.83	32.86	400	1.9						-
			V	8.28	9.90	12.12	14.00	19.80	24.25	28.00	31.30	38.34		400	2.3					-

※ For MPa / bar / psi units, please refer to LORRIC.com.

Spray Angle	Capacity Code	Thread Size			Capacity at Pressure									Average particle size (um)	Min. Free Passage (mm)	Filter mesh
		1/8	1/4	3/8	0.7 kgf/cm ²	1 kgf/cm ²	1.5 kgf/cm ²	2 kgf/cm ²	4 kgf/cm ²	6 kgf/cm ²	8 kgf/cm ²	10 kgf/cm ²	15 kgf/cm ²			
90°	10	V	V		0.59	0.71	0.87	1.00	1.41	1.73	2.00	2.24	2.74	-	-	-
	15	V	V		0.89	1.06	1.30	1.50	2.12	2.60	3.00	3.35	4.11	-	-	-
	20	V	V		1.18	1.41	1.73	2.00	2.83	3.46	4.00	4.47	5.48	-	-	-
	25	V	V		1.48	1.77	2.17	2.50	3.54	4.33	5.00	5.59	6.85	-	-	-
	30	V	V		1.77	2.12	2.60	3.00	4.24	5.20	6.00	6.71	8.22	-	-	-
	35	V	V		2.07	2.47	3.03	3.50	4.95	6.06	7.00	7.83	9.59	-	-	-
	40	V	V		2.37	2.83	3.46	4.00	5.66	6.93	8.00	8.94	10.95	-	-	-
	50		V	V	2.96	3.54	4.33	5.00	7.07	8.66	10.00	11.18	13.69	-	-	-
	60		V	V	3.55	4.24	5.20	6.00	8.49	10.39	12.00	13.42	16.43	-	-	-
	70		V	V	4.14	4.95	6.06	7.00	9.90	12.12	14.00	15.65	19.17	-	-	-
	80		V	V	4.73	5.66	6.93	8.00	11.31	13.86	16.00	17.89	21.91	-	-	-
	100			V	5.92	7.07	8.66	10.00	14.14	17.32	20.00	22.36	27.39	-	-	-
	120			V	7.10	8.49	10.39	12.00	16.97	20.78	24.00	26.83	32.86	-	-	-
	140			V	8.28	9.90	12.12	14.00	19.80	24.25	28.00	31.30	38.34	-	-	-
120°	10	V	V		0.59	0.71	0.87	1.00	1.41	1.73	2.00	2.24	2.74	-	-	-
	15	V	V		0.89	1.06	1.30	1.50	2.12	2.60	3.00	3.35	4.11	-	-	-
	20	V	V		1.18	1.41	1.73	2.00	2.83	3.46	4.00	4.47	5.48	-	-	-
	25	V	V		1.48	1.77	2.17	2.50	3.54	4.33	5.00	5.59	6.85	-	-	-
	30	V	V		1.77	2.12	2.60	3.00	4.24	5.20	6.00	6.71	8.22	-	-	-
	35	V	V		2.07	2.47	3.03	3.50	4.95	6.06	7.00	7.83	9.59	-	-	-
	40	V	V		2.37	2.83	3.46	4.00	5.66	6.93	8.00	8.94	10.95	-	-	-
	50		V	V	2.96	3.54	4.33	5.00	7.07	8.66	10.00	11.18	13.69	-	-	-
	60		V	V	3.55	4.24	5.20	6.00	8.49	10.39	12.00	13.42	16.43	-	-	-
	70		V	V	4.14	4.95	6.06	7.00	9.90	12.12	14.00	15.65	19.17	-	-	-
	80		V	V	4.73	5.66	6.93	8.00	11.31	13.86	16.00	17.89	21.91	-	-	-
	100			V	5.92	7.07	8.66	10.00	14.14	17.32	20.00	22.36	27.39	-	-	-
	120			V	7.10	8.49	10.39	12.00	16.97	20.78	24.00	26.83	32.86	-	-	-
	140			V	8.28	9.90	12.12	14.00	19.80	24.25	28.00	31.30	38.34	-	-	-

※ For MPa / bar / psi units, please refer to LORRIC.com.

KJ Female thread metal full cone nozzle



- Recommended working pressure: 2.8 kgf/cm²
- Flowrate tolerance: ± 5% @ 2.8 ± 0.1 kgf/cm²
- Angle tolerance: ± 5° @ 2.8 ± 0.1 kgf/cm²

【 Top view of nozzle spray pattern 】



【 Flow distribution 】

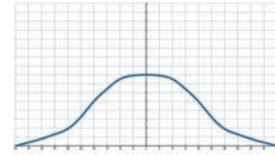

Full Cone Nozzles

Features

- Full cone spray.
- Adopts a Holeless multi-slotted core, possess a more uniform impact than other standard solid cone nozzles of the same type. It is often used in the iron and steel industry where cooling homogeneity is extremely demanding. e.g. Steel bloom cooling and iron and steel continuous casting process.
- Hexagonal body, convenient installation; single-piece design, the multi-slotted core is embedded and compressed into the body to avoid losing performance from thermal expansion and shrinkage.

Applications

- Cleaning: Gas, exhaust gas, dust, cleaners, etc.
- Cooling: Gas, tank, machinery, metal, etc.
- Dispersion: Humidifying, fire fighting, and dust suppression.

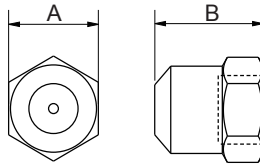

Appearance dimensions may vary depending on model, material. Please ask for details.

Material	Serie	Unit (mm)		Thread Type	Weight (g)		
		A	B		S303	S316	Brass
Metal	3/8KJ	22	27	3/8F	50.4	50	51.8

Material

- Metal: Stainless 303, Stainless 316, BRASS

How to place an order for LORRIC nozzles?

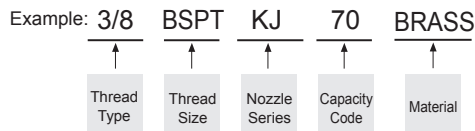

※ Standard Pressure: Column in red.
 ※ This product for spray angle 90° and 120° is able to be made to order.

Spray Angle	Capacity Code	Capacity at Pressure									Average particle size (um)	Min. Free Passage (mm)	Filter mesh
		0.7 kgf/cm ²	1 kgf/cm ²	1.5 kgf/cm ²	2 kgf/cm ²	2.8 kgf/cm ²	4 kgf/cm ²	6 kgf/cm ²	10 kgf/cm ²	15 kgf/cm ²			
68°	70	3.50	4.19	5.13	5.92	7.00	8.37	10.25	13.24	16.21	-	1.9	-

※ For MPa / bar / psi units, please refer to LORRIC.com.

KG Metal full cone nozzle



- Recommended working pressure: 2.0 kgf/cm²
- Flowrate tolerance: ± 5% @ 2.0 ± 0.1 kgf/cm²
- Angle tolerance: ± 5° @ 2.0 ± 0.1 kgf/cm²

【 Top view of nozzle spray pattern 】

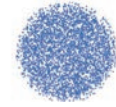

【 Flow distribution 】

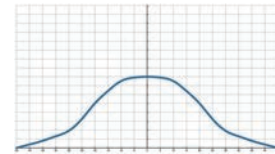

Features

- Full cone spray.
- Unibody design allows for secure and easy installation, and X-shaped core provides minimal clogging.
- Three-piece structure facilitates maintenance cleaning and replacement, and can save the cost of replacing the nozzle head. Expenditure filter design, easy maintenance, reduced blocking, and reduced cleaning due to maintenance. When the

hole is clogged, it may damage the nozzle hole.

Applications

- Cleaning: Gas, exhaust gas, dust, cleaners, etc.
- Cooling: Gas, tank, machinery, metal, etc.
- Dispersion: Humidifying, fire fighting, and dust suppression.

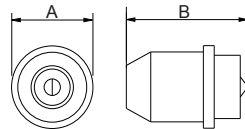

Material	Serie	Unit (mm)		Thread Type	Weight (g)		
		A	B		S303	S316	Brass
Metal	1/8KG	21	45	1/8M			
	1/4KG	21	47	1/4M	10.4	10.6	11.5
	3/8KG	21	47	3/8M			

Appearance dimensions may vary depending on model, material. Please ask for details.

Material

- Metal: Stainless 303, Stainless 316, BRASS

How to place an order for LORRIC nozzles?

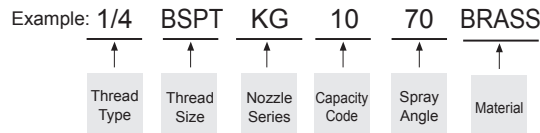

※ Standard Pressure: Column in red.
 ※ This product for spray angle 90° and 120° is able to be made to order.

Spray Angle	Capacity Code	Capacity at Pressure									Average particle size (um)	Min. Free Passage (mm)	Filter mesh
		0.5 kgf/cm ²	0.7 kgf/cm ²	1 kgf/cm ²	1.5 kgf/cm ²	2 kgf/cm ²	2.5 kgf/cm ²	3 kgf/cm ²	5 kgf/cm ²	10 kgf/cm ²			
70°	10	3.10	3.67	4.38	5.37	6.20	6.93	7.59	9.80	13.86	-	1.7	-

※ For MPa / bar / psi units, please refer to LORRIC.com.

Hollow Cone Nozzles

LORRIC[®]
paranoid about performance

ST	66
MWT	67
QSWP	68

ST Plastic hollow cone nozzle for cooling



- Recommended working pressure: 0.1 kgf/cm²
- Flowrate tolerance: ± 10% @ 0.1 ± 0.05 kgf/cm²

【Top view of nozzle spray pattern】



【Flow distribution】

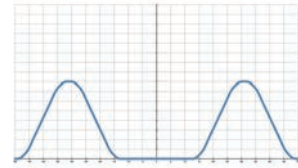

Features

- Spray patterns: Hollow Cone. Spray shape is circular (Circular Impact).
- Shark teeth design provides more liquid surface for better cooling performance. No complicated structure in the nozzle flow path provides the maximum free passage of 40mm which effectively avoids clogging.
- Two piece nozzle design enables easy cleaning and

installation.

- The minimum operating pressure can be reduced to 0.05kgf/cm².

Applications

- Cleaning: Gas, cleaning, etc.
- Cooling: Gas, liquid cooling, etc.

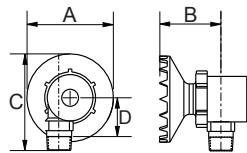

Material	Serie	Unit (mm)				Thread Type	Weight (g) FRPP
		A	B	C	D		
Plastic	1-1/2ST	165	175	119	26	1-1/2M	376

Appearance dimensions may vary depending on model, material. Please ask for details.

Material

- Strengthened Pipe Fiberglass PP

How to place an order for LORRIC nozzles?

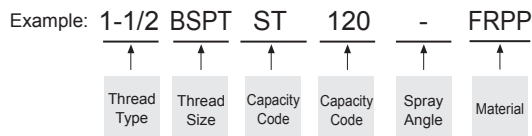

※ Standard Pressure: Column in red.

Spray Angle	Capacity Code	Thread Size	Capacity at Pressure									Average particle size (um)	Min. Free Passage (mm)	Filter mesh
			1-1/2	0.05 kgf/cm ²	0.07 kgf/cm ²	0.1 kgf/cm ²	0.2 kgf/cm ²	0.3 kgf/cm ²	0.5 kgf/cm ²	0.7 kgf/cm ²	1 kgf/cm ²			
-	120	v	84.85	100	120	169	207	268	317	379	536	-	-	-
	122	v	86.3	102	122	172	211	272	322	385	545	-	-	-
	147	v	104	122	147	207	254	328	388	464	657	-	-	-

※ For MPa / bar / psi units, please refer to LORRIC.com.

MWT Metal hollow cone nozzle



- Recommended working pressure: 2.0 kgf/cm²
- Flowrate tolerance: ± 5% @ 2.0 ± 0.1 kgf/cm²
- Angle tolerance: ± 5° @ 2.0 ± 0.1 kgf/cm²

【 Top view of nozzle spray pattern 】



【 Flow distribution 】

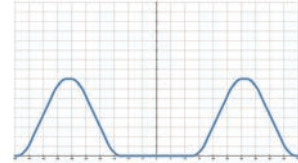

Features

- Spray patterns: Hollow Cone. The shape of the spray is circular (circular Impact).
- The nozzle flow path has no complicated structure and effectively prevents foreign matter from being blocked.
- Two piece nozzle design enables easy clean and installation.
- The direction of the spray is 90 degrees to the mounting direction. Please confirm that the installation environment

meets the requirements.

- Under the same test conditions, the hollow cone spray has the smallest particle size, so it is commonly used in gas scrubbing and dust suppression applications.

Applications

- Cleaning: Gas cleaning etc.
- Cooling: Gas, liquid, air conditioning, machinery, metal, plastic molding cooling process.
- Dispersion: Humidifying, aeration, firefighting, dedusting, deodorization, etc.

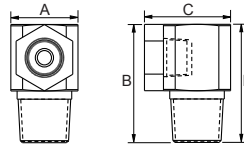

Appearance dimensions may vary depending on model, material. Please ask for details.

Material	Serie	Unit (mm)				Thread Type	Weight (g)	
		A	B	C	D		S303	S316
Plastic	1/8MWT	13	22	15	16	1/8M	-	-
	1/4MWT	16	29	18	21	1/4M	39	39.5
	3/8MWT	19	35	20	24	3/8M	-	-

Material

- Metal: Stainless 303, Stainless 316

How to place an order for LORRIC nozzles?

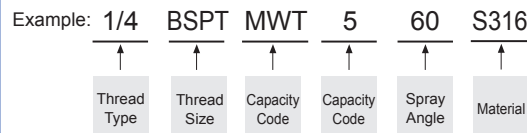

※ Standard Pressure: Column in red.

Spray Angle	Capacity Code	Capacity at Pressure									Average particle size (um)	Min. Free Passage (mm)	Filter mesh
		0.7 kgf/cm ²	1 kgf/cm ²	1.5 kgf/cm ²	2 kgf/cm ²	4 kgf/cm ²	6 kgf/cm ²	8 kgf/cm ²	10 kgf/cm ²	15 kgf/cm ²			
60°	3	1.77	2.12	2.60	3.00	4.24	5.20	6.00	6.71	8.22	230	3	-
	5	2.96	3.54	4.33	5.00	7.07	8.66	10.00	11.18	13.69		4	-

※ For MPa / bar / psi units, please refer to LORRIC.com.

QSWP

Plastic hollow cone nozzle with pipe clamp



- Recommended working pressure: 2.0 kgf/cm²
- Flowrate tolerance: ± 10% @ 2.0 ± 0.1 kgf/cm²
- Angle tolerance: ± 10° @ 2.0 ± 0.1 kgf/cm²

【 Top view of nozzle spray pattern 】



【 Flow distribution 】

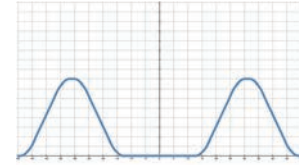

Features

- Spray patterns: Hollow Cone. The shape of the spray is circular.
- The nozzle flow path has no complicated structure which effectively avoids clogging.
- Multi-piece design, the nozzle part adopts a two-piece structure. The nozzle part can be disassembled to facilitate maintenance, cleaning and replacement; the nozzle part and the base buckle are positioned by the clamp, and the installation can be completed with bare hands without tools.
- The internal gaskets have different options such as TPR, Viton and Viton-F. They can be equipped with a variety of chemical product processes, and the special structural design allows the nozzles and the base to fit tightly to avoid water leakage.

- The spray direction is 90 degrees to the installation direction. Please make sure that the installation environment meets the requirements (The base is shared with the QSH and QSF nozzles. If the spray direction is limited, QSH can be used with the QSF nozzle head)
- Under the same test conditions, the hollow cone spray has the smallest particle size, so that it is commonly applicable in gas washing and dust suppression.
- Size:
 - Drilling hole size for pipe clamp: 9.8~10mm
 - Fits pipe size: 3/4"(OD26 +/-0.2mm), 1"(OD34 +/-0.3mm)

Applications

- Cleaning: Gas, cleaning, etc.
- Cooling: Gas, liquid, air conditioning, machinery, metal, plastic molding cooling process.
- Dispersion: Humidifying, aeration, firefighting, dedust, deodorization, etc.

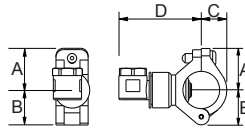

Appearance dimensions may vary depending on model, material. Please ask for details.

Material	Serie	Unit (mm)				Thread Type	Weight (g)
		A	B	C	D		
Plastic	3/4QSWP	24	27	14	60	3/4M	27
	1 QSWP	28	33	22	62	1	30.5

Material

- Nozzle: PP
- Body: Strengthened Pipe Fiberglass PP

How to place an order for LORRIC nozzles?

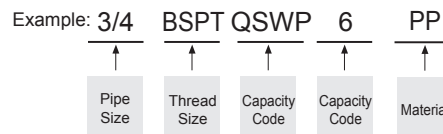

※ Standard Pressure: Column in red.
 ※ This product for spray angle 90° and 120° is able to be made to order.

Spray Angle	Capacity Code	Thread Size		Capacity at Pressure									Average particle size (um)	Min. Free Passage (mm)	Filter mesh
		3/4	1	0.5 kgf/cm ²	0.7 kgf/cm ²	1 kgf/cm ²	1.5 kgf/cm ²	2 kgf/cm ²	2.5 kgf/cm ²	3 kgf/cm ²	4 kgf/cm ²	6 kgf/cm ²			
90°	6	v	v	1.00	1.18	1.41	1.73	2.00	2.24	2.45	2.83	3.46	220	2.2	-

※ For MPa / bar / psi units, please refer to LORRIC.com.

Others Nozzles



SPP	70
ED	71
ED MINI	72
BB	73
TB	73

SPP Spiral Nozzle



- Recommended working pressure: 2.0 kgf/cm²
- Flowrate tolerance: ± 5% @ 2.0 ± 0.1 kgf/cm²
- Angle tolerance: ± 5° @ 2.0 ± 0.1 kgf/cm²

【 Top view of nozzle spray pattern 】



【 Flow distribution 】

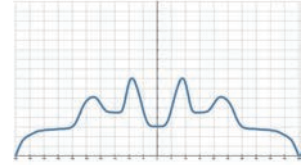

Features

- Spray patterns: Full Cone. Spray shape is multi-layered concentric circles.
- Unibody design with no internal parts. To compare with general full cone nozzles, It has a larger minimum free passage for effectively avoiding clogging.
- The spray angle is from 120° to 170°. This large spray angle design provides larger coverage than general fan and full cone

nozzles.

- It is possible to work when under 0.5kgf/cm².

Applications

- Cleaning: scrubber, off-gas treatment, etc.
- Cooling: cooling tower, etc.
- Dispersion: firefighting.

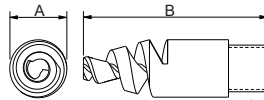

Appearance dimensions may vary depending on model, material. Please ask for details.

Material	Serie	Unit (mm)		Thread Type	Weight (g)	
		A	B		PVC	PEEK
Plastic	1/4SPP	52	16	1/4M	6.5	6.5
	3/8SPP	61	20	3/8M	16	16
	1/2SPP	77	22	1/2M	13	13
	3/4SPP	90	28	3/4M	30	30

Material

- Body: U-PVC, PEEK

How to place an order for LORRIC nozzles?

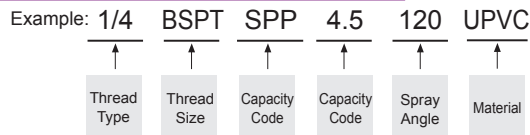

※ Standard Pressure: Column in red.

Spray Angle	Capacity Code	Thread Size				Capacity at Pressure							Min. Free Passage (mm)	Eq. Orifice (mm)	Average particle size (um)	Filter mesh
		1/4	3/8	1/2	3/4	0.5 kgf/cm ²	0.7 kgf/cm ²	1 kgf/cm ²	2 kgf/cm ²	3 kgf/cm ²	4 kgf/cm ²	5 kgf/cm ²				
120°	4.5	v				2.25	2.66	3.18	4.50	5.51	6.36	7.12	1.55	2.38	228	-
	12.8	v				6.40	7.57	9.05	12.8	15.68	18.10	20.24	2.53	3.97	-	-
170°	52.7		v			26.4	31.2	37.3	52.7	64.5	74.5	83.3	3.00	7.94	380	-
	105			v		52.5	62.1	74.2	105	129	148	166	4.75	11.1	388	-
	134				v	67.0	79.3	94.8	134	164	190	212	4.75	12.7	416	-

※ For MPa / bar / psi units, please refer to LORRIC.com.

ED Educator nozzle for mixing

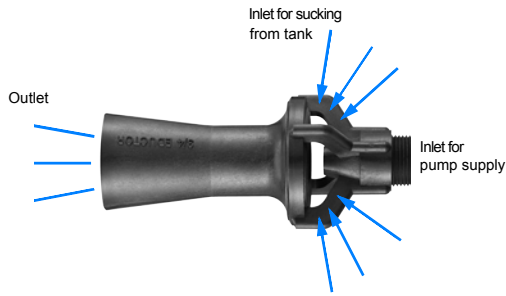

- Recommended working pressure: 0.5 kgf/cm²
- Flowrate tolerance: ± 10% @ 0.5 ± 0.1 kgf/cm²

Features

- Used for liquid stirring under the liquid surface. Specially designed nozzle that creates a stirring and circulating effect. This nozzle can mix chemicals, direct the suspended substances to a filter and prevent precipitation.
- Energy-efficiency of liquid stirring: the educator nozzles are designed to suck and spray liquid through the amplified nozzle tube to increase liquid flow rate up to 4 times which provides more efficient stirring than aeration or robot arms

(Quantity supplied+Intake=Total Flow).

- Single piece structure and hand installable without any tools.

Applications

- Cleaning: scrubber, off-gas treatment, etc.
- Cooling: cooling tower, etc.
- Dispersion: firefighting.

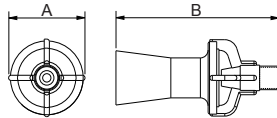

Appearance dimensions may vary depending on model, material. Please ask for details.

Material	Serie	Unit (mm)		Thread Type	Weight (g)	
		A	B		S316	FRPP
Metal	3/8ED	116	54	3/8M	274	-
	3/4ED	159	74	3/4M	-	84.6

Material

- Strengthened Pipe Fiberglass PP
- Stainless 316 (Only 3/8")

How to place an order for LORRIC nozzles?

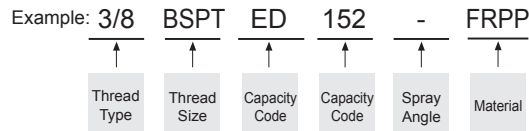

※ Standard Pressure: Column in red.

Thread Size	Capacity Code	Magnification	Definition of flow	Capacity at Pressure								
				0.1 kgf/cm ²	0.25 kgf/cm ²	0.5 kgf/cm ²	0.75 kgf/cm ²	1 kgf/cm ²	1.5 kgf/cm ²	2 kgf/cm ²	3 kgf/cm ²	4 kgf/cm ²
3/8	63	5.0	Quantity supplied	5.59	8.84	12.50	15.31	17.68	21.65	25.00	30.62	35.36
			Intake	22.36	35.36	50.01	61.25	70.72	86.61	100.01	122.49	141.44
			Total Flow	27.95	44.20	62.51	76.56	88.40	108.27	125.02	153.11	176.80
	152		Quantity supplied	10.87	17.18	24.30	29.76	34.36	42.08	48.59	59.51	68.72
			Intake	43.46	68.72	97.18	119.03	137.44	168.33	194.37	238.05	274.88
			Total Flow	54.33	85.90	121.48	148.78	171.80	210.41	242.96	297.57	343.60
3/4	-	Quantity supplied	19.57	30.94	43.75	53.58	61.87	75.77	87.50	107.16	123.74	
		Intake	78.26	123.74	174.99	214.32	247.48	303.10	349.99	428.65	494.96	
		Total Flow	97.83	154.68	218.74	267.90	309.35	378.87	437.49	535.81	618.70	

※ For MPa / bar / psi units, please refer to LORRIC.com.

Mini ED Small eductor nozzle for mixing and plating

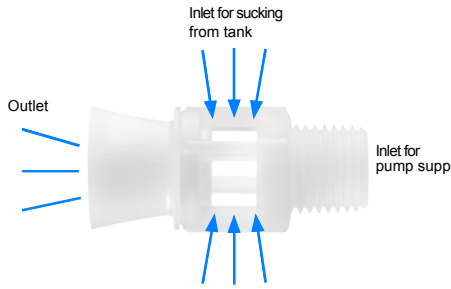

- Recommended working pressure: 0.5 kgf/cm²
- Flowrate tolerance: ± 10% @ 0.5 ± 0.1 kgf/cm²

Features

- Used for liquid stirring under the liquid surface. Specially designed nozzle that creates a stirring and circulating effect. This nozzle can mix chemicals, direct the suspended substances to a filter and prevent precipitation.
- Energy-efficiency of liquid stirring: the eductor nozzles are designed to suck and spray liquid through the amplified nozzle tube to increase liquid flow rate up to 4 times which provides more efficient stirring than aeration or robot arms

(Quantity supplied+Intake=Total Flow).

- Single piece structure and hand installable without any tools.

Applications

- Cleaning: scrubber, off-gas treatment, etc.
- Cooling: cooling tower, etc.
- Dispersion: firefighting.

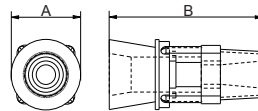

Material	Serie	Unit (mm)				Thread Type	Weight (g)
		A	B	C	D		
Plastic	1/4EDMINI	40	30	18	20	1/4M	3.5

Appearance dimensions may vary depending on model, material. Please ask for details.

Material

- PP

How to place an order for LORRIC nozzles?

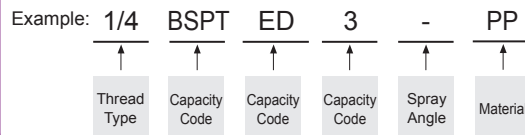

※ Standard Pressure: Column in red.

Capacity Code	Magnification	Definition of flow	Capacity at Pressure								
			0.1 kgf/cm ²	0.25 kgf/cm ²	0.5 kgf/cm ²	0.75 kgf/cm ²	1 kgf/cm ²	1.5 kgf/cm ²	2 kgf/cm ²	3 kgf/cm ²	4 kgf/cm ²
3	2.4	Quantity supplied	1.36	2.14	3.03	3.71	4.29	5.25	6.06	7.42	8.57
		Intake	1.88	2.97	4.20	5.14	5.94	7.27	8.40	10.3	11.9
		Total Flow	3.23	5.11	7.23	8.85	10.2	12.5	14.5	17.7	20.4
9	1.6	Quantity supplied	4.02	6.36	9.00	11.0	12.7	15.6	18.0	22.0	25.5
		Intake	2.41	3.82	5.40	6.61	7.64	9.35	10.8	13.2	15.3
		Total Flow	6.44	10.2	14.4	17.6	20.4	24.9	28.8	35.3	40.7

※ For MPa / bar / psi units, please refer to LORRIC.com.

BB Angle adjustable and easy install stopper nozzle with pipe clamp



Features

- Female nut for fixing nozzle is easy to loosen for adjusting nozzle angle.
- Amazingly easy to drill a hole instead of threading onto a pipe and fix it on with our exclusive pipe clamp without any tool.
- For stopping spaying, if one or a few of the holes on pipe need to be stopped.
- The size for drilling the installation hole:
 - Ø 15 (14.3~15mm) - Ø 17 (16.4~17mm)
 - Ø 20 (19.0~20mm) 8.35~9m/m
- Size of clamp:
 - 1" (OD34 +/-0.3mm) - 1-1/4" (OD42+/-0.3mm)
 - 1-1/2" (OD48 +/-0.4mm)

Applications

- Coating
- Cleaning

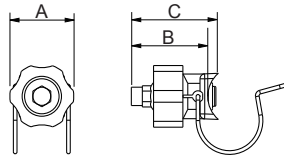

Material	Serie	Unit (mm)			Pipe Size	Weight (g)
		A	B	C		
Plastic	BB	52	64	72	-	63.2

Appearance dimensions may vary depending on model, material. Please ask for details.

Material

- Nozzle part: PP
- Nut: fiberglass, Strengthening PP
- Pipe clamp: Stainless 316
- Sealing ring: NBR

TB Angle adjustable and easy install nozzle thread adapter with pipe clamp



Features

- Female nut for fixing nozzle is easy to loosen for adjusting nozzle angle.
- A mazingly easy to drill a hole instead of threading onto a pipe and fix it on with our exclusive pipe clamp without any tool.
- This accessory is available with a 1/4" or 3/8" PT female thread for flexible use with other kind of nozzles.
- The size for drilling the installation hole:
 - Ø 15 (14.3~15mm) - Ø 17 (16.4~17mm)
 - Ø 20 (19.0~20mm)
- Size of clamp:
 - 1" (OD34 +/-0.3mm) - 1-1/4" (OD42+/-0.3mm)
 - 1-1/2" (OD48 +/-0.4mm)

Applications

- Coating
- Cleaning

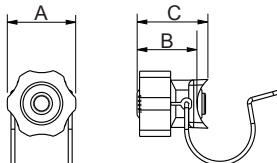

Material	Serie	Unit (mm)			Pipe Size	Weight (g)
		A	B	C		
Plastic	TB	52	48	56	-	64

Appearance dimensions may vary depending on model, material. Please ask for details.

Material

- Nozzle part: fiberglass, Strengthening PP
- Nut: fiberglass, Strengthening PP
- Pipe clamp: Stainless 316
- Sealing ring: NBR

Nozzle Accessories

LORRIC[®]
paranoid about performance

QFSA 76

QFWG 76



QFSA QF body for 3/4 inch PVC pipe



Features

- Joint by PVC welding.
- To save time for repositioning when maintaining nozzles, and this way of installation is stronger than threads.
- Especially well applicable in manufacturing processes with periodical maintenance such as PCB wet process.

Applications

- PCB Wet Processing

Material

- Body: U-PVC
- Oring: EPDM, VITON, VITON-F

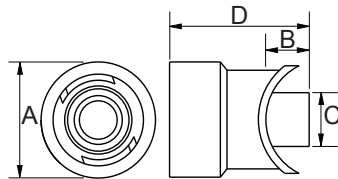

Appearance dimensions may vary depending on model, material. Please ask for details.

Material	Serie	Unit (mm)				Thread Type	Weight (g) PVC
		A	B	C	D		
Plastic	QFSA	26	10	12	31	-	8.6

QFWG QF body for welding



Features

- Joint by PVC welding.
- To save time for repositioning when maintaining nozzles, and this way of installation is stronger than threads.
- Especially well applicable for horizontal installation such as PCB spray plate.

Applications

- Horizontal installation such as PCB spray plate.

Material

- Body: U-PVC
- Oring: EPDM, VITON, VITON-F

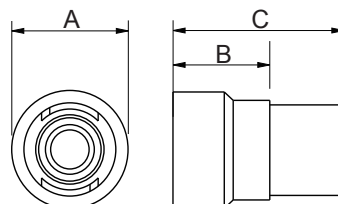

Appearance dimensions may vary depending on model, material. Please ask for details.

Material	Serie	Unit (mm)				Thread Type	Weight (g) PVC
		A	B	C	D		
Plastic	QFWG	26	17	38	20	-	12

Why LORRIC

LORRIC[®]
paranoid about performance

Flat fan nozzle's estimated spray coverage	78
Immediately understanding how to read "Flow Rate" ..	79
Comparison of particle size of 3 common kinds of nozzles ..	79
3 facts you must know about "spray angle"	80
Impact vs pressure distribution	81

Flat fan nozzle's estimated spray coverage

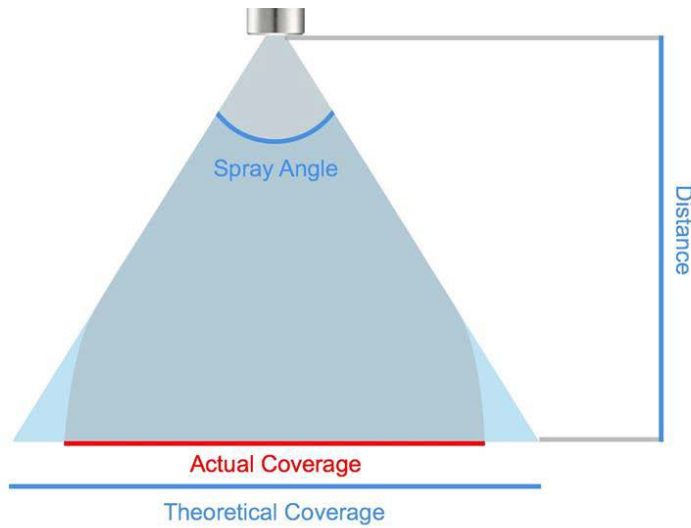

Flat fan nozzle spray coverage is affected by a myriad of factors, such as gravity, acceleration and air resistance. That combined with the technical specifications of the nozzles themselves which dictate spray pressure and viscosity, thus further influencing spray coverage, all lead to the fact that there's no way to predict nozzle spray coverage in a completely accurate manner. Thus, the following information is a theoretical estimation, prior to the influence of external factors. For further information regarding more practical spray coverage, be sure to contact our sales rep.

Spray Angle (°)	Theoretical Coverage (mm)					
	65	80	90	100	120	170
30	38	50	60	72	104	686
40	51	67	80	95	139	914
50	64	84	100	119	173	1143
60	76	101	120	143	208	1372
70	89	117	140	167	242	1600
80	102	134	160	191	277	1829
90	115	151	180	215	312	2057
100	127	168	200	238	346	2286
110	140	185	220	262	381	2515
120	153	201	240	286	416	2743
130	166	218	260	310	450	2972
140	178	235	280	334	485	3200
150	191	252	300	358	520	3429
200	255	336	400	477	693	4572
250	319	420	500	596	866	5715
300	382	503	600	715	1039	6858
350	446	587	700	834	1212	8001
400	510	671	800	953	1386	9144
450	573	755	900	1073	1559	1028
500	637	839	1000	1192	1732	1143
550	701	923	1100	1311	1905	1257
600	764	1007	1200	1430	2078	1371
650	828	1091	1300	1549	2252	1485
700	892	1175	1400	1668	2425	1600
750	956	1259	1500	1788	2598	1714
800	1019	1343	1600	1907	2771	1828
850	1083	1426	1700	2026	2944	1943
900	1147	1510	1800	2145	3118	2057
950	1210	1594	1900	2264	3291	2171
1000	1274	1678	2000	2384	3464	2286

Measurement in millimeters

Spray Angle (°)	Theoretical Coverage (inch)						
	40	65	80	90	100	120	170
1.0	0.7	1.3	1.7	2.0	2.4	3.5	23
1.5	1.1	1.9	2.5	3.0	3.6	5.2	34
2.0	1.5	2.5	4.2	4.0	6.0	8.7	57
2.5	1.8	3.2	5.0	5.0	7.2	10	69
3.0	2.2	3.8	5.0	6.0	7.2	10	69
3.5	2.5	4.5	5.9	7.0	8.3	12	80
4.0	2.9	5.1	6.7	8.0	10	14	91
4.5	3.3	5.7	7.6	9.0	11	16	103
5	3.6	6.4	8.4	10	12	17	114
6	4.4	7.6	10	12	14	21	137
7	5.1	8.9	12	14	17	24	160
8	5.8	10	13	16	19	28	183
9	6.6	11	15	18	21	31	206
10	7.3	13	17	20	24	35	229
11	8.0	14	18	22	26	38	251
12	8.7	15	20	24	29	42	274
14	10	18	23	26	33	48	320
16	12	20	27	28	38	55	366
18	13	23	30	32	43	62	411
20	15	25	34	36	48	69	457
22	16	28	37	40	52	76	503
24	17	31	40	44	57	83	549
26	19	33	44	48	62	90	594
28	20	36	47	52	67	97	640
30	22	38	50	56	72	104	686
32	23	41	54	60	76	111	732
34	25	43	57	64	81	118	777
36	26	46	60	60	86	125	823

Measurement in inches

Immediately understanding how to read “Flow Rate”

Immediately understanding how to read “Flow Rate”

Unit: LPM (L/min)

Features:

- Greater the pressure, greater the flow rate.
- Flow rate and pressure are not linear relationship.
- For example, the flow rate of a nozzle under 8kg/cm² pressure is not double when it is under ekg/cm² pressure.

Distribution

Mountain Shape

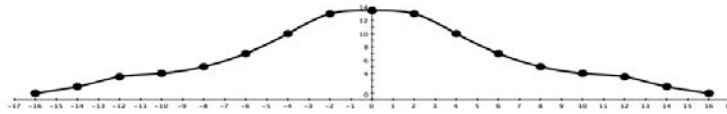

Tableland Shape

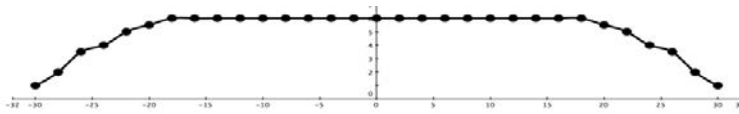

Donut Shape

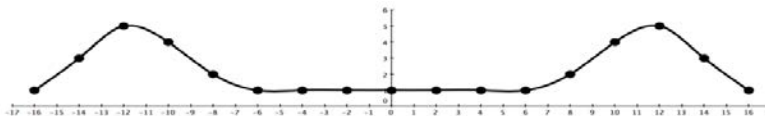

What else you must know about flow rate?

1. Distribution of flow rate often varies by variety of pressure.
2. Distribution shapes are for reference, they may be vary during operating.
3. Distribution will be effected by flow angle and flow rate.

Comparison of particle size of 3 common kinds of nozzles

The average particle size of 3 common kinds of spray shape

Following, LORRIC use laser diffraction particle size analyzer to get the particle sizes of 3 different kinds of nozzle which is under 2kg pressure and 2Lpm flow rate.

Various nozzles	Average spray particle size	Comparison of particle size
Cone shape	274um	Coarse
Fan shape	234um	Fine
Hollow Cone	221um	Finest

Features of particle size

- Smaller the flow rate, finer the particle size.
- Greater the pressure, finer the particle size.
- Particle size will be varied by nozzles with different structure.

3 facts you must know about “spray angle”



① Easy understanding “spray angle” by 5 sentences

The definition of “Spray angle ” is the angle of spray shape. (please refer to schematic diagram)

We lists following 5 easy sentences for you to quick understand what is “spray angle”

- Unit: degree
- Spray angle is the index for simplifying spray coverage.
- Spray is not able to travel in tangential direction which is caused by the effects of gravitational acceleration and air resistance.
- Spray angle and pressure is inevitable relationship.

② Spray angle and coverage

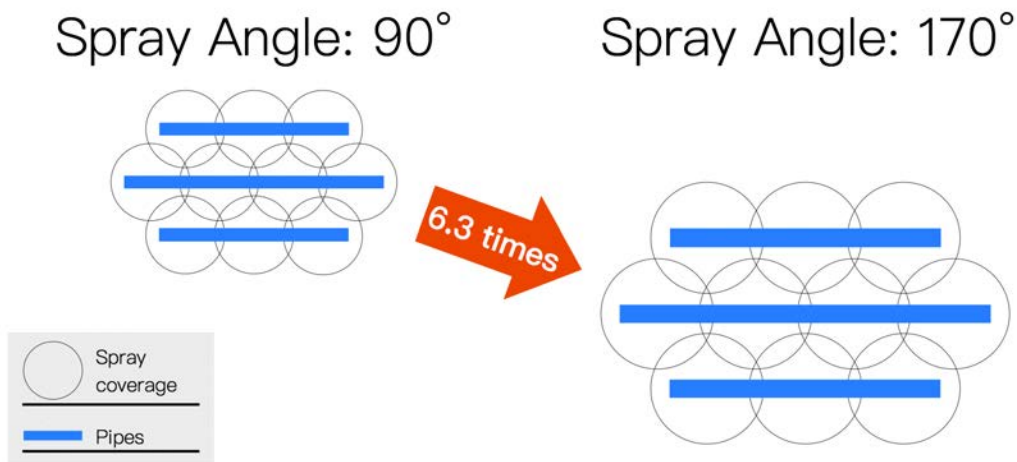

Theoretical spray coverage under 300mm spray distance

- 90°Spray angle: The spray distance is 60cm, and the spray coverage is 0.28m²/per nozzle.
- 170°Spray angle: The spray distance is 150cm, and the spray coverage is 1.76m²/per nozzle. (about 6.3 times)

③ 3 key “distance” decision making points to choose spray angle of nozzles

It is able to find out the spray angle you need for choosing nozzles by following 3 kinds of “distance” with 2 charts, The measurement of theoretical coverage by spray distance for flat fan nozzle, The measurement of theoretical coverage by spray distance for full cone nozzle

- Distance between nozzle and spray target



- Distance between beside nozzles
- Distance between pipes: Besides fan nozzles, this is very important factor to choose the spray angle of cone nozzles, hollow cone nozzles, and spiral nozzles.

Impact vs pressure distribution

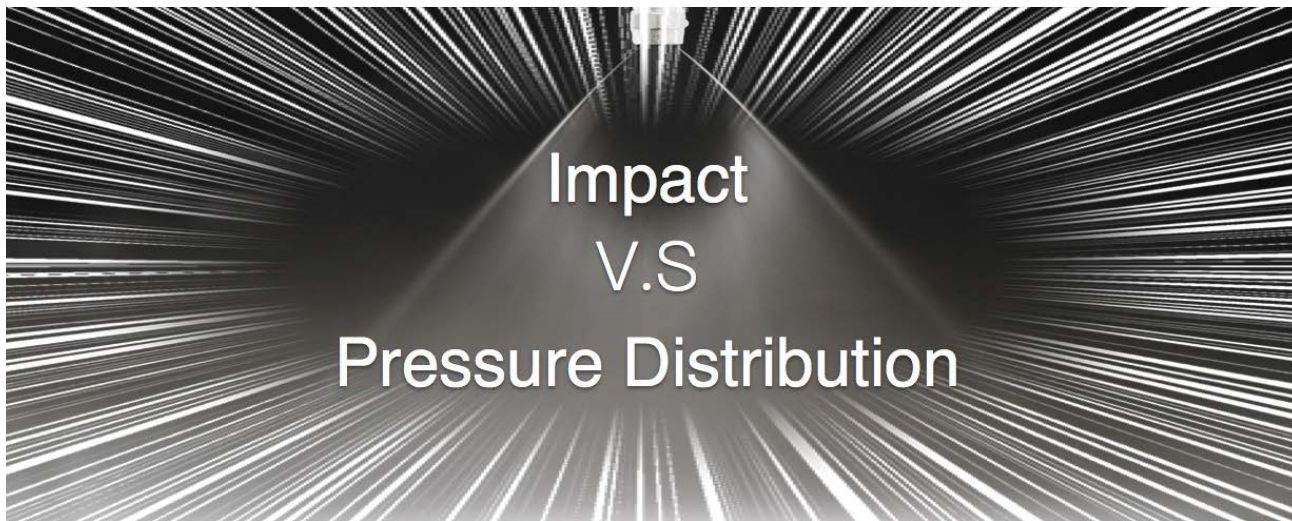

- **Impact is total force**

- Which is proportional to flow rate.
- Which is proportional to the square root of pressure.

- **The definition of pressure distribution is the pressure which is sprayed to every part of workpiece by nozzles.**

- Variation of impact will effect pressure distribution.
- The result of pressure distribution will be effected by spray shape and coverage volume.
- Pressure distribution is related to spray flow rate and effected by the design of flow distribution.
- As there is so many variables, there is no any simple formula to receive pressure distribution of various nozzles.

Contents

LORRIC Flow Meter Features		2
LORRIC Flow Meter Specs		4
Liquid Flowmeter	F10	8
	F20	10
	F22	12
	F30	14
	F32B	16
	F34	18
	F45	20
	F45M	22
	F46	24
	F101	26
	F201	28
	F301	30
	F311	32
	FU-TX 310	34
Gas Flowmeter	F20A	38
	F30A	40
	F201A	42
	F301A	44

LORRIC

paranoid about performance

LORRIC Patented Dual-indicator Flow Meter Introduce

LORRIC F10

The smallest LORRIC variable area flowmeter. Can be installed into small spaces to help reduce costs and reduce size of equipment.



- Adaptor Size: 1/2"
- Body Height: 168mm
- Scale Range: 0.2-2 ~ 2-20L/min

LORRIC F20

F20 is the standard model of LORRICs variable area flowmeters. Optional Hastelloy C float material which is applicable for any fluid.



- Adaptor Size: 3/4", 1/2"
- Body Height: 196mm
- Scale Range: 1-10 ~ 5-50L/min

LORRIC F30

F30 is a larger model than the F20 flowmeter. Optional Hastelloy C float material which is applicable for any fluid.



- Adaptor Size: 1/2", 3/4", 1"
- Body Height: 270mm
- Scale Range: 2-20 ~ 10-100L/min



Patented dual-indicator

Design for easy and clear flow range management.



Various material options for each part

For example, options for the body material could be PC or PSU.



Easy measurement for solvents and dark liquid

Customized scales for different solvents are available for F45-Magnetic.

LORRIC F32

Designed for use with highly corrosive solutions. The inductor can be connected to instruments or computers and is often used as part of the control or alarm system.



- Adaptor Size: 1/2", 3/4", 1"
- Body Height: 195mm
- Scale Range: 9-18 ~ 45-90L/min

LORRIC F45

Adaptor size is 1 to 2 inches which is applicable to major equipments. Magnetic indicator is optional.

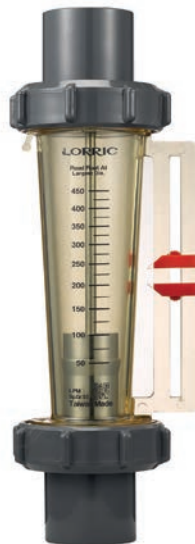

- Adaptor Size: 1-1/2", 2"
- Body Height: 346mm
- Scale Range: 10-100 ~ 100-600L/min

LORRIC F46

Adaptor size is 1 to 2 inches for large pipes with highly corrosive solutions.



- Adaptor Size: 1-1/2", 2"
- Body Height: 346mm
- Scale Range: 20-100 ~ 60-300L/min

■ LORRIC Patented Dual-indicator Flow Meter Specs Form 【Liquid】

Specs	Body Material	Scale Range (L/min)	Float&Pointer		O-ring	Union Nuts Materia	Guide Rod Bottom Materia	Adaptor Size	Adaptor Materia																		
			stainless steel 0001~0030	Hastelloy 0001~0027					Male/Female Thread	Welding Type	Butt-fusion adaptor	Panel Elbow / Flange															
F10 / F101	PC (polycarbonate) PSU (polyulf-one)	0.2-2	S316 Float / Pointer	Hastelloy C Float & Ti Pointer or Hastelloy C Pointer	Standard EPDM or VITON	Standard UPVC or PSU	Standard UPVC or PSU Guide Rod Bottom	1/2"	Standard UPVC or PSU or PP	UPVC	PP	Panel Elbow Male Thread UPVC															
		0.4-4																									
		0.5-5																									
		1-10																									
		1.5-15																									
		2-20																									
F20 / F201		1-10						S316 Float / Pointer				Hastelloy C Float & Ti Pointer or Hastelloy C Pointer	Standard EPDM or VITON	Standard UPVC or PSU	Standard UPVC or PSU Guide Rod Bottom	Standard 3/4" or 1/2"	Standard UPVC or PSU or PP	UPVC	PP	Panel Elbow Male Thread UPVC							
		1.5-15																									
		2-20																									
		3-30																									
		4-40																									
		5-50																									
F30 / F301	2-20	S316 Float / Pointer	Hastelloy C Float & Ti Pointer or Hastelloy C Pointer	Standard EPDM or VITON	Standard UPVC or PSU	Standard UPVC or PSU Guide Rod Bottom	Standard 1" or 3/4"		Standard UPVC or PSU or PP	UPVC	PP					Panel Elbow Male Thread UPVC											
	3-30																										
	4-40																										
	5-50																										
	6-60																										
	7-70																										
F45	8-80						S316 Float / Pointer	Hastelloy C Float & Ti Pointer or Hastelloy C Pointer				Standard EPDM or VITON	Standard UPVC or PSU	Standard UPVC or PSU Guide Rod Bottom	Standard 1"-1/2" or 2"	Standard UPVC or PSU or PP	UPVC	PP	Flange UPVC 2"								
	10-100																										
	15-150																										
	20-200																										
	25-250																										
	30-300																										
F45M	50-450	S316 Float / Pointer	Hastelloy C Float & Ti Pointer or Hastelloy C Pointer	Standard EPDM or VITON	Standard UPVC or PSU	Standard UPVC or PSU Guide Rod Bottom			Standard 1"-1/2" or 2"	Standard UPVC or PSU or PP	UPVC				PP				Flange UPVC 2"								
	100-600																										
	50-300																										
F22	PC (polycarbonate)								S316 Float / Pointer										Hastelloy C Float & Ti Pointer or Hastelloy C Pointer	Standard EPDM or VITON	Standard UPVC or PSU	Standard UPVC or PSU Guide Rod Bottom	Standard 3/4" or 1/2"	Standard UPVC or PSU or PP	UPVC	PP	No
	0.3-4																										
	0.5-5																										
	0.8-8																										
	1-10																										
500L/h																											

【 Order Example 】

The form at the bottom of page 5 is an example for placing orders or for requesting samples. Please fill up the products information as shown in the example and send to us by FAX or email. We are looking forward to your inquiry.

Specs	Body Material	Scale Range (L/min)	Float&Pointer		O-ring	Union Nuts Material	Guide Rod Bottom Material	Adaptor Size	Adaptor Material			
			stainless steel 0001~0030	Hastelloy 0001~0027					Male/Female Thread	Welding Type	Butt-fusion adaptor	Panel Elbow / Flange
F32	PC (polycarbonate) PSU (polyulfone)	9-18	PP Float	Standard EPDM or VITON	UPVC	PP Guide Rod Bottom	Standard 1" or 3/4"	Standard UPVC or PSU or PP	UPVC	PP	No	
		16-32										
		30-60										
		45-90										
F34		3-30										
		5-50										
		6-60										
		8-80										
F311	23-80	S316 or Hastelloy C Float	Standard EPDM or VITON	UPVC	PP Guide Rod Bottom	Standard 1" or 3/4"	Standard UPVC or PSU or PP	UPVC	PP	No		
	20-100	Teflon Float										
F46	PSU (polyulfone)	20-100	PP Float	Standard EPDM or VITON	UPVC	PP Guide Rod Bottom	Standard 1"-1/2" or 2"	Standard UPVC or PSU or PP	UPVC	PP	No	
		30-150										
		40-200										
		60-300										

LORRIC Patented Dual-indicator Flow Meter Specs Form [Gas]

Specs	Body Material	Scale Range L/min	Float	Guide Rod	O-ring	Union Nuts Material	Guide Rod Bottom Material	Adaptor Size	Adaptor Material			
									Male/Female Thread	Welding Type	Butt-fusion adaptor	Panel Elbow
F20A / F201A	PSU (polyulfone)	3.0-30	PVC	Standard SUS 316 or Ti Pointer or Hastelloy C Pointer	Standard EPDM or VITON	Standard UPVC or PVDF	Standard UPVC or PSU	Standard 3/4" or 1/2"	Standard UPVC or PSU or PP	UPVC	PP	Panel Elbow UPVC or Male Thread
		5.0-50										
		10-100										
		35-350										
F20AH		50-500	Hastelloy C									
		100-1000										
		35-350										
F30A F301A		50-500	PVC									
	70-700											
	100-1000											
	100-1000	S316										
F30AH	100-1000	Hastelloy C										

Order Example:

F10	PC	20	Stainless steel Float	EPDM	UPVC	PSU	1/2" Female Thread	Panel Elbow UPVC	Quantity

Liquid Flowmeter

LORRIC[®]
paranoid about performance

F10	8
F20	10
F22	12
F30	14
F32B	16
F34	18
F45	20
F45M Magnetic Dual-Indicator...	22
F46	24
F101	26
F201	28
F301	30
F311	32
FU-TX 310	34

F10Series - 168mm small size pipe size 1/2" F10 series

This product will stop production by December 31st, 2018.

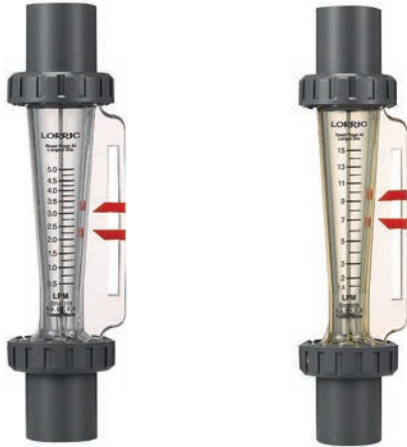

Product Features · Use

- Patented dual-indicator design for easy and clear flow range management.
- Laser engraved degree scales provide better readability and longer life.
- Available in customizable units, temperature, and molecular weight.
- Each batch of flow meters will be calibrated before delivery for our best precision guarantee.
- Perpendicular joint is available for space saving installation.
- Hastelloy float is available for corrosive environment.

Standard Specs

- Model: F10PC, F10PSU, F10H PSU
- Adaptor Size: 1/2"
- Applicable Fluid: Liquid
- Flow direction: From the bottom up
- Fluid Temperature: 50°C (standard)
- Working Pressure: 6.0 kg/cm² MAX
- Full Scale Accuracy: ±5% F.S.
- Product Material

Body - PC, PSU
 Float - Stainless 316, Ti, Hastelloy C
 Guide Rod - Stainless 316, Ti, Hastelloy C
 Guide Rod Bottom - PP, PSU
 Adaptor - Welding Type: UPVC
 Male, Female Thread: UPVC, PP, PVDF
 Butt-fusion Adaptor: PP
 Panel Elbow Male Thread: UPVC

- Union Nuts - UPVC, Aluminum
- O -ring - EPDM, VITON
- Adaptor Material
- Welding Type, Male Thread, Female Thread,
 Butt-fusion Adaptor, Panel Elbow Male Thread

※ BSPT is standard thread type. NPT is available for custom order.

Scale Range

Product Code	Scale Range※	Standard gravity
F10 (PC,PSU,H PSU) -2LPM	0.2-2.0 L/min	1.0
F10 (PC,PSU,H PSU) -4LPM	0.4-4.0 L/min	1.0
F10 (PC,PSU,H PSU) -5LPM	0.5-5.0 L/min	1.0
F10 (PC,PSU,H PSU) -10LPM	1.0-10 L/min	1.0
F10 (PC,PSU,H PSU) -15LPM	1.5-15 L/min	1.0
F10 (PC,PSU,H PSU) -20LPM	2.0-20 L/min	1.0

※ Liquid flow meters are calibrated for 20°C water.

Maximum working temperature for different adaptor materials

Adaptor Types	Maximum working temperature materials		
	~ 50°C	~ 60°C	~ 100°C
Welding Type	UPVC	-	-
Male / Female Thread	UPVC	PP	PSU
Butt-fusion Adaptor	PP	PP	-
Panel Elbow Male Thread	UPVC	-	-

※ When maximum working temperature is over 50°C, the material for guide rod bottom and union nuts have to be PSU and aluminium.

Parts Material

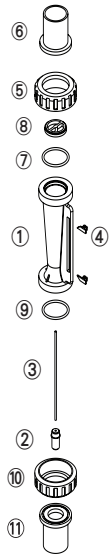

No.	Series	Material (Main material)*			
		1	2	3	4
1	Body	PC	PC	PSU	PSU
2	Float	S316	S316	Hastelloy C	Hastelloy C
3	Guide Rod	S316	S316	Ti	Hastelloy C
4	Pointer	ABS	ABS	ABS	ABS
5,10	Union Nuts	UPVC	UPVC	UPVC	Aluminum
6,11	Adaptor	UPVC	UPVC	UPVC	UPVC
7,9	O-ring	EPDM	VITON	VITON	VITON
8	Guide Rod Bottom	UPVC	UPVC	PSU	PSU

* Material for different parts is optional for each flowmeter.

Parts Size

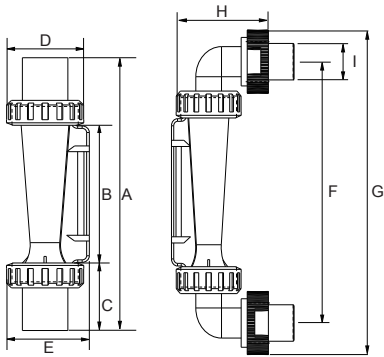

Adaptor Material	A	B	C	D	E	F	G	H	I
1/2" Female Thread	163	88	37.5	41	48	-	-	-	-
1/2" Male Thread	164	88	38	41	48	-	-	-	-
1/2" JIS	166	88	39	41	48	-	-	-	-
PP OD25 ID20	166	88	39	41	48	-	-	-	-
PP OD27.65 ID18.93	168	88	40	41	48	-	-	-	-
1/2" PT Panel Elbow Male Thread	-	88	-	41	45	153	189	47	22

Unit: mm

Specification inquiry (F10)

* Contact us with below information.

- Fluid - Water Other _____
- Specific gravity - Standard-1.0 Other _____
- Pressure - Standard-6.0kg/cm² Other __ kg/cm²
- Temperature - Normal temperature Other ____ °C
- Scale Range - _____ L/min ~ _____ L/min
- Adaptor Size - 3/4" JIS Other _____
- Adaptor Material - Welding Type Male Thread
 - Female Thread Butt-fusion Adaptor
 - Panel Elbow Thread Other _____

- Material
 - 1 Body PC 2 Body PSU
 - 3 Body PSU Hastelloy C Float, Ti Guide Rod
 - 4 Body PSU Hastelloy C Float & Guide Rod Adaptor PSU (for high working temperature)
 - 5 Other
 Specs besides above listed information _____

F20Series - 192mm middle size pipe size 1/2"-3/4" **F20 series**

This product will stop production by December 31st, 2018.

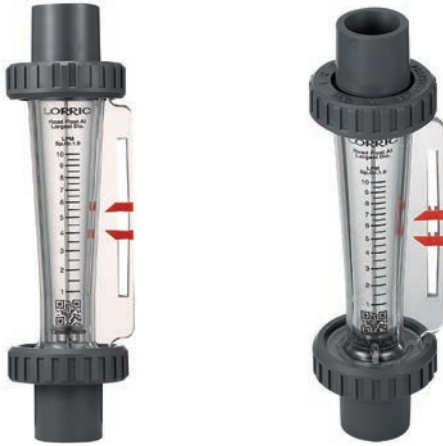

Product Features · Use

- Patented dual-indicator design for easy and clear flow range management.
- Laser engraved degree scales provide better readability and longer life.
- Available in customizable units, temperature, and molecular weight.
- Each batch of flow meters will be calibrated before delivery for our best precision guarantee.
- Perpendicular joint is available for space saving installation.
- Hastelloy float is available for corrosive environment.

Standard Specs

- Model: F20PC, F20PSU, F20H PSU
- Adaptor Size: 1/2", 3/4"
- Applicable Fluid: Liquid
- Flow direction: From the bottom up
- Engraved degree scales: Laser engraved degree scales
- Fluid Temperature: 50°C (Standard: UPVC adaptor)
60°C (PP adaptor)
100°C (PSU adaptor)
- Working Pressure: 6.0kg/cm²
- Full Scale Accuracy: ±5% F.S.
- Product Material
 - Body - PC, PSU
 - Float - Stainless 316, Ti, Hastelloy C
 - Guide Rod - Stainless 316, Ti, Hastelloy C
 - Guide Rod Bottom - UPVC, PSU
 - Adaptor - Welding Type: UPVC
Male, Female Thread: UPVC, PP, PSU
Butt-fusion Adaptor: PP
Panel Elbow Thread: UPVC, PVC
 - Union Nuts - UPVC, Aluminum
 - O-ring - EPDM, VITON
- Adaptor Material
 - Welding Type, Male Thread, Female Thread, Butt-fusion Adaptor

※BSPT is standard thread type. NPT is available for custom order.

Scale Range

Product Code	Scale Range※	Standard gravity
F20 (PC, PSU, H PSU) - 10LPM	1.0-10 L/min	1.0
F20 (PC, PSU, H PSU) - 15LPM	1.5-15 L/min	1.0
F20 (PC, PSU, H PSU) - 20LPM	2.0-20 L/min	1.0
F20 (PC, PSU, H PSU) - 30LPM	3.0-30 L/min	1.0
F20 (PC, PSU, H PSU) - 40LPM	4.0-40 L/min	1.0
F20 (PC, PSU, H PSU) - 50LPM	5.0-50 L/min	1.0

※ Liquid flow meters are calibrated for 20°C water.

Maximum working temperature for different adaptor materials

Adaptor Types	Maximum working temperature materials		
	~ 50°C	~ 60°C	~ 100°C
Welding Type	UPVC	-	-
Male / Female Thread	UPVC	PP	PSU
Butt-fusion Adaptor	PP	PP	-
Panel Elbow Male Thread	UPVC	-	-

※ When maximum working temperature is over 50°C, the material for guide rod bottom and union nuts have to be PSU and aluminium.

Parts Material

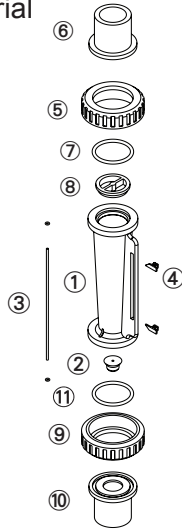

No.	Series	Material (Main material)* 1			
		1	2	3	4
1	Body	PC	PSU	PSU	PSU
2	Float	S316	S316	Hastelloy C	Hastelloy C
3	Guide Rod	S316	S316	Ti	Hastelloy C
4	Pointer	ABS	ABS	ABS	ABS
5,10	Union Nuts	UPVC	UPVC	UPVC	PSU
6,11	Adaptor	UPVC	UPVC	UPVC	PSU**2
7,9	O-ring	EPDM	VITON	VITON	VITON
8	Guide Rod Bottom	UPVC	UPVC	PSU	PSU

※ 1. Material for different parts is optional for each flowmeter.
 ※ 2. For thread adaptor only.

Parts Size

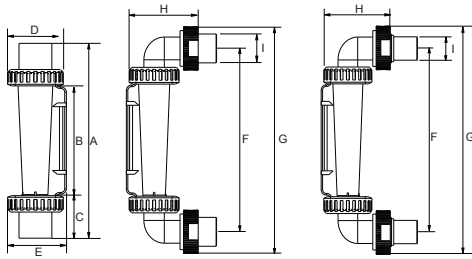

Adaptor Material	A	B	C	D	E	F	G	H	I
3/4" Male Thread	192	104	44	51	56.5	-	-	-	-
3/4" Female Thread	189	104	42.5	51	56.5	-	-	-	-
3/4" JIS	199	104	47.5	51	56.5	-	-	-	-
PP OD32 ID26	181	104	38.5	51	56.5	-	-	-	-
PP OD32.2 ID26.2	192	104	44	51	56.5	-	-	-	-
1/2" Male Thread	192	104	44	51	56.5	-	-	-	-
1/2" Female Thread	184	104	40	51	56.5	-	-	-	-
1/2" JIS	185	104	40.5	51	56.5	-	-	-	-
3/4" PT Panel Elbow Male Thread	-	104	-	51	56.5	180	219	55	27

Unit: mm

Specification inquiry (F20)

※ Contact us with below information.

- Fluid - Water Other _____
 - Specific gravity - Standard-1.0 Other _____
 - Pressure - Standard-6.0kg/cm² Other ___ kg/cm²
 - Temperature - Normal temperature Other ____ °C
 - Scale Range - _____ L/min ~ _____ L/min
 - Adaptor Size - 3/4" JIS Other _____
 - Adaptor Material - Welding Type Male Thread
 - Female Thread Butt-fusion Adaptor
 - Panel Elbow Thread Other _____
 - Material
 - 1 Body PC 2 Body PSU
 - 3 Body PSU Hastelloy C Float, Ti Guide Rod
 - 4 Body PSU Hastelloy C Float & Guide Rod Adaptor PSU (for high working temperature)
 - 5 Other
- Specs besides above listed information _____

F22Series - 192mm middle size pipe size 1/2"-3/4" **F22 series**



Product Features · Use

- Designed for use with highly corrosive solutions.
- Equipped with an inductor, which confirms the pipeline's current capacity by means of detecting the floating migration. The inductor can be connected instruments or computers and is often used as part of the control or alarm system.
- Patented dual-indicator design for easy and clear flow range management.
- Laser engraved degree scales provide better readability and longer life.
- Available in customizable units, temperature, and molecular weight.
- Each batch of flow meters will be calibrated before delivery for our best precision guarantee.

Standard Specs

- Model: F22PSU, F22 w/ Inductor PSU
- Adaptor Size: 1/2", 3/4"
- Applicable Fluid: Liquid (Highly corrosive)
- Flow direction: From the bottom up
- Engraved degree scales: Laser engraved degree scales
- Fluid Temperature: 50°C (Standard: UPVC adaptor)
60°C (PP adaptor)
- Working Pressure: 6.0kg/cm²
- Full Scale Accuracy: ±5% F.S.
- Product Material

Body - PSU
 Float - PP, PVDF, Telfone
 Guide Rod - No
 Guide Rod Bottom - PP
 Adaptor - Welding Type: UPVC
 Male, Female Thread: UPVC, PP, PSU
 Butt-fusion Adaptor: PP

Union Nuts - UPVC
 O-ring- EPDM, VITON

- Adaptor Material
- Welding Type, Male Thread, Female Thread,
 Butt-fusion Adaptor

※BSPT is standard thread type. NPT is available for custom order.

Scale Range

Product Code	Scale Range*	Standard gravity
F22-4PM PVC float	0.3-4.0 L/min	1.0
F22-5LPM PVDF float	0.5-5.0 L/min	1.0
F22-8LPM Teflon float	0.8-8.0 L/min	1.0
F22-10LPM Teflon float	1.0-10 L/min	1.0
F22-500LPH Teflon float	50-500 L/h	1.0
F22 w/ inductor-6LPM PP float	0.5-6.0 L/min	1.0
F22 w/ inductor-11LPM PVDF float	1.0-11 L/min	1.0

※ Liquid flow meters are calibrated for 20°C water.

Maximum working temperature for different adaptor materials

Adaptor Types	Maximum working temperature materials		
	~ 50°C	~ 60°C	~ 100°C
Welding Type	UPVC	-	-
Male / Female Thread	UPVC	PP	PSU
Butt-fusion Adaptor	PP	PP	-
Panel Elbow Male Thread	UPVC	-	-

※ When maximum working temperature is over 50°C, the material for union nuts/ guide rod bottom and O-ring have to be PSU and VITON.

Parts Material

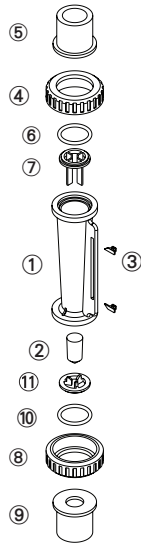

No.	Series	Material (Main material)* 1			
		1	2	3	4
1	Body	PSU	PSU	PSU	PSU
2	Float	PP/ PVDF / Teflon	PP/ PVDF / Teflon	PP/ PVDF / Teflon	PP/ PVDF / Teflon
3	Guide Rod	ABS	ABS	ABS	ABS
4,8	Pointer	UPVC	UPVC	UPVC	PSU
5,9	Adaptor	UPVC	UPVC	PP* 2	PSU* 3
6,10	O-ring	EPDM	VITON	VITON	VITON
7,11	Guide Rod Bottom	PP	PP	PP	PP

- ※ 1. Material for different parts is optional for each flowmeter.
- ※ 2. For thread and welding adaptor only.
- ※ 3. For thread adaptor only.

Parts Size

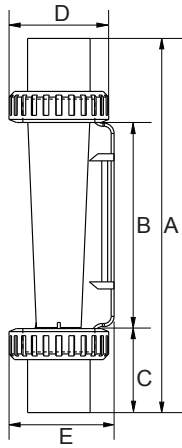

Adaptor Material	A	B	C	D	E
3/4" Male Thread	191	104	43.5	51	54
3/4" Female Thread	188	104	42	51	54
3/4" JIS	194	104	45	51	54
1/2" Male Thread	182	104	39	51	54
1/2" Female Thread	191	104	43.5	51	54
1/2" JIS	183	104	39.5	51	54
PP OD20 ID15.3	184	104	40	51	54

Unit: mm

Specification inquiry (F22)

※ Contact us with below information.

- Fluid - _____
- Specific gravity - Standard-1.0 Other _____
- Pressure - Standard-6.0kg/cm² Other ___ kg/cm²
- Temperature - Normal temperature Other ___ °C
- Scale Range - _____ L/min ~ _____ L/min
- Adaptor Size - 3/4" JIS
 Other _____
- Adaptor Material
 - Welding Type Male Thread
 - Female Thread Butt-fusion Adaptor
 - Panel Elbow Thread Other _____
- Inductor - Yes No
- Other - _____

F30Series - 270mm large size pipe size 3/4"-1" F30 series

This product will stop production by December 31st, 2018.



Product Features · Use

- Patented dual-indicator design for easy and clear flow range management.
- Laser engraved degree scales provide better readability and longer life.
- Available in customizable units, temperature, and molecular weight.
- Each batch of flow meters will be calibrated before delivery for our best precision guarantee.
- Perpendicular joint is available for space saving installation.
- Hastelloy float is available for corrosive environment.

Standard Specs

- Model: F30PC, F30PSU, F30H PSU
- Adaptor Size: 1/2", 3/4", 1"
- Applicable Fluid: Liquid
- Flow direction: From the bottom up
- Engraved degree scales: Laser engraved degree scales
- Fluid Temperature: 50°C (Standard: UPVC adaptor)
60°C (PP adaptor)
100°C (PSU adaptor)
- Working Pressure: 6.0 kg/cm²
- Full Scale Accuracy: ±5% F.S.
- Product Material

Body - PC, PSU
 Float - Stainless 316, Ti, Hastelloy C
 Guide Rod - Stainless 316, Ti, Hastelloy C
 Guide Rod Bottom - UPVC, PSU
 Adaptor - Welding Type: UPVC
 Male, Female Thread: UPVC, PP, PVDF, PSU, Stainless 316
 Butt-fusion Adaptor: PP
 Panel Elbow Thread: UPVC

Union Nuts - UPVC, Aluminum
 O-ring / EPDM, VITON

- Adaptor Material
- Welding Type, Male Thread, Female Thread,
 Butt-fusion Adaptor, Panel Elbow Thread

※ BSPT is standard thread type. NPT is available for custom order.

Scale Range

Product Code	Scale Range*	Standard gravity
F30 (PSU, H PSU) - 20LPM	2.0-20 L/min	1.0
F30 (PSU, H PSU) - 30LPM	3.0-30 L/min	1.0
F30 (PSU, H PSU) - 40LPM	4.0-40 L/min	1.0
F30 (PSU, H PSU) - 50LPM	5.0-50 L/min	1.0
F30 (PSU, H PSU) - 60LPM	6.0-60 L/min	1.0
F30 (PSU, H PSU) - 70LPM	7.0-70 L/min	1.0
F30 (PSU, H PSU) - 80LPM	8.0-80 L/min	1.0
F30 (PSU, H PSU) - 100LPM	10-100 L/min	1.0

※ Liquid flow meters are calibrated for 20°C water.

Maximum working temperature for different adaptor materials

Adaptor Types	Maximum working temperature materials		
	~ 50°C	~ 60°C	~ 100°C
Welding Type	UPVC	-	-
Male / Female Thread	UPVC	PP	PSU
Butt-fusion Adaptor	PP	PP	-
Panel Elbow Male Thread	UPVC	-	-

※ When maximum working temperature is over 50°C, the material for guide rod bottom and union nuts have to be PSU and aluminium.

Parts Material

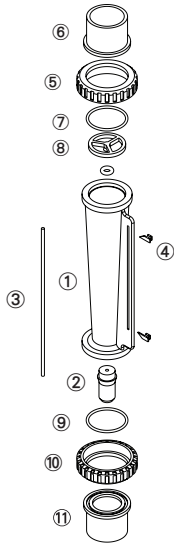

No.	Series	Material (Main material)* 1			
		1	2	3	4
1	Body	PC	PSU	PSU	PSU
2	Float	S316	S316	Hastelloy C	Hastelloy C
3	Guide Rod	S316	S316	Ti	Hastelloy C
4	Pointer	ABS	ABS	ABS	ABS
5,10	Union Nuts	UPVC	UPVC	UPVC	PSU
6,11	Adaptor	UPVC	UPVC	UPVC	PSU* 2
7,9	O-ring	EPDM	VITON	VITON	VITON
8	Guide Rod Bottom	PP	PP	PSU	PSU

※ 1. Material for different parts is optional for each flowmeter.
 ※ 2. For thread adaptor only.

Parts Size

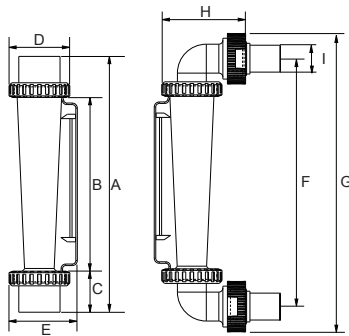

Adaptor Material	A	B	C	D	E	F	G	H	I
1" Male Thread	272	171	50.5	60	67.5	-	-	-	-
1" Female Thread	272	171	50.5	60	67.5	-	-	-	-
1" JIS	253	171	41	60	67.5	-	-	-	-
PP D33 ID25.2	254	171	41.5	60	67.5	-	-	-	-
3/4" Male Thread	257	171	43	60	67.5	-	-	-	-
3/4" JIS	256	171	42.5	60	67.5	-	-	-	-
1"PTPanel ElbowMale Thread	-	171	-	60	67.5	255	284	67	26.6

Unit: mm

Specification inquiry (F30)

※ Contact us with below information.

- Fluid - Water Other _____
- Specific gravity - Standard-1.0 Other _____
- Pressure - Standard-6.0kg/cm² Other ___ kg/cm²
- Temperature - Normal temperature Other ___ °C
- Scale Range - _____ L/min ~ _____ L/min
- Adaptor Size - 3/4" JIS Other _____
- Adaptor Material - Welding Type Male Thread
 Female Thread Butt-fusion Adaptor
 Other _____

- Material
 - 1 Body PC 2 Body PSU
 - 3 Body PSU Hastelloy C Float, Ti Guide Rod
 - 4 Body PSU Hastelloy C Float & Guide Rod
Adaptor PSU (for high working temperature)
 - 5 Other
Specs besides above listed information _____

F32B Series - 195mm middle size pipe size 1/2"-1" **F32B series**



Product Features · Use

- Designed for use with highly corrosive solutions.
- Equipped with an inductor, which confirms the pipeline's current capacity by means of detecting the floating migration. The inductor can be connected instruments or computers and is often used as part of the control or alarm system.
- Patented dual-indicator design for easy and clear flow range management.
- Laser engraved degree scales provide better readability and longer life.
- Available in customizable units, temperature, and molecular weight.
- Each batch of flow meters will be calibrated before delivery for our best precision guarantee.

Standard Specs

- Model: F32B PSU, F32B w/ Inductor PSU
- Adaptor Size: 1/2", 3/4", 1"
- Applicable Fluid: Liquid (Highly corrosive)
- Flow direction: From the bottom up
- Engraved degree scales: Laser engraved degree scales
- Fluid Temperature: 50°C (Standard: UPVC adaptor) 60°C (PP adaptor)

- Working Pressure: 6.0 kg/cm²
- Full Scale Accuracy: ±5% F.S.
- Product Material

Body - PSU
 Float - PVC, PP, PVDF, Teflon
 Guide Rod - None
 Guide Rod Bottom - PP
 Adaptor - Welding Type: UPVC
 Male, Female Thread: UPVC, PP
 Butt-fusion Adaptor: PP

Union Nuts - UPVC
 O-ring - EPDM, VITON

- Adaptor Material
- Welding Type, Male Thread, Female Thread, Butt-fusion Adaptor

※ BSPT is standard thread type. NPT is available for custom order.

Scale Range

Product Code	Scale Range※	Standard gravity
F32B - 18LPM	9.0-18 L/min	1.0
F32B - 32LPM	16-32 L/min	1.0
F32B - 60LPM	30-60 L/min	1.0
F32B - 90LPM	45-90 L/min	1.0

※ Liquid flow meters are calibrated for 20°C water.

Maximum working temperature for different adaptor materials

Adaptor Types	Maximum working temperature materials	
	~ 50°C	~ 60°C
Welding Type	UPVC	-
Male / Female Thread	UPVC	PP
Butt-fusion Adaptor	PP	PP
Panel Elbow Male Thread	UPVC	-

Parts Material

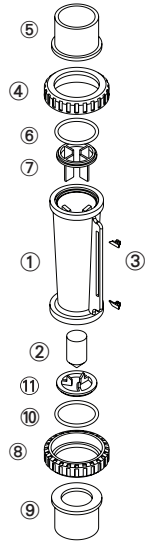

No.	Series	Material (Main material)* 1			
		1	2	3	4
1	Body	PSU	PSU	PSU	PSU
2	Float	PP	PP	PP	PP
3	Guide Rod	ABS	ABS	ABS	ABS
4,8	Pointer	UPVC	UPVC	UPVC	UPVC
5,9	Adaptor	UPVC	UPVC	PP* 2	PSU* 3
6,10	O-ring	EPDM	VITON	VITON	VITON
7,11	Guide Rod Bottom	PP	PP	PP	PP

- ※ 1. Material for different parts is optional for each flowmeter.
- ※ 2. For thread and welding adaptor only.
- ※ 3. For thread adaptor only.

Parts Size

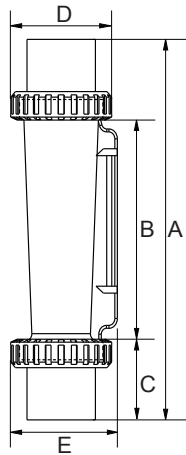

Adaptor Material	A	B	C	D	E
1" Male Thread	210	111	49.5	60	64
1" Female Thread	210	111	49.5	60	64
1" JIS	195	111	42	60	64
3/4" Male Thread	196	111	42.5	60	64
3/4" Female Thread	211	111	50	60	64
3/4" JIS	200	111	44.5	60	64
1/2" JIS	190	111	39.5	60	64
PP OD40.4 ID35	197	111	43	60	64
PP OD33 ID25.3	193	111	41	60	64

Unit: mm

Specification inquiry (F32B)

※ Contact us with below information.

- Fluid - _____
- Specific gravity - Standard-1.0 Other _____
- Pressure - Standard-6.0kg/cm² Other ___ kg/cm²
- Temperature - Normal temperature Other ___ °C
- Scale Range - _____ L/min ~ _____ L/min
- Adaptor Size - 1" JIS
 Other _____
- Adaptor Material
 - Welding Type Male Thread
 - Female Thread Butt-fusion Adaptor
 - Other _____
- Inductor - Yes No
- Other - _____

F34Series - 270mm large size pipe size 1/2"-1" F34 series



Product Features · Use

- Designed for use with highly corrosive solutions.
- Equipped with an inductor, which confirms the pipeline's current capacity by means of detecting the floating migration. The inductor can be connected instruments or computers and is often used as part of the control or alarm system.
- Patented dual-indicator design for easy and clear flow range management.
- Laser engraved degree scales provide better readability and longer life.
- Available in customizable units, temperature, and molecular weight.
- Each batch of flow meters will be calibrated before delivery for our best precision guarantee.

Standard Specs

- Model: F34 PSU, F34 w/ Inductor PSU
- Adaptor Size: 1/2", 3/4", 1"
- Applicable Fluid: Liquid (Highly corrosive)
- Flow direction: From the bottom up
- Engraved degree scales: Laser engraved degree scales
- Fluid Temperature: 50°C (Standard: UPVC adaptor)
60°C (PP adaptor)
- Working Pressure: 6.0 kg/cm²
- Full Scale Accuracy: ±5% F.S.

Product Material

- Body - PSU
- Float - PP, PVDF
- Guide Rod - No
- Guide Rod Bottom - PP
- Adaptor - Welding Type: UPVC
Male, Female Thread: UPVC, PP, PSU
Butt-fusion Adaptor: PP
- Union Nuts - UPVC
- O-ring - EPDM, VITON

Adaptor Material

- Welding Type, Male Thread, Female Thread,
Butt-fusion Adaptor

※ BSPT is standard thread type. NPT is available for custom order.

Scale Range

Product Code	Scale Range*	Standard gravity
F34 - 30LPM	3.0-30 L/min	1.0
F34 - 50LPM	5.0-50 L/min	1.0
F34 - 60LPM	6.0-60 L/min	1.0
F34 - 80LPM	8.0-80 L/min	1.0
F34 - 100LPM	10-100 L/min	1.0
F34 - 120LPM	12-120 L/min	1.0

※ Liquid flow meters are calibrated for 20°C water.

Maximum working temperature for different adaptor materials

Adaptor Types	Maximum working temperature materials	
	~ 50°C	~ 60°C
Welding Type	UPVC	-
Male / Female Thread	UPVC	PP
Butt-fusion Adaptor	PP	PP
Panel Elbow Male Thread	UPVC	-

Parts Material

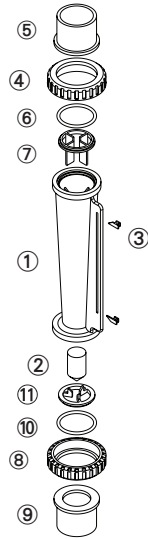

No.	Series	Material (Main material)* 1			
		1	2	3	4
1	Body	PSU	PSU	PSU	PSU
2	Float	PP	PP	PP	PP
3	Guide Rod	ABS	ABS	ABS	ABS
4,8	Pointer	UPVC	UPVC	UPVC	UPVC
5,9	Adaptor	UPVC	UPVC	PP** 2	PSU** 3
6,10	O-ring	EPDM	VITON	VITON	VITON
7,11	Guide Rod Bottom	PP	PP	PP	PP

※ 1. Material for different parts is optional for each flowmeter.
 ※ 2. For thread and welding adaptor only.
 ※ 3. For thread adaptor only.

Parts Size

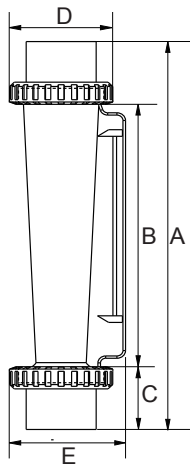

Adaptor Material	A	B	C	D	E
1" Male Thread	270	171	49.5	60	68
1" Female Thread	270	171	49.5	60	68
1" JIS	255	171	42	60	68
3/4" Male Thread	256	171	42.5	60	68
3/4" Female Thread	271	171	50	60	68
3/4" JIS	260	171	44.5	60	68
1/2" JIS	249	171	39	60	68
PP OD40.4 ID35	257	171	43	60	68
PP OD33 ID25.3	253	171	41	60	68

Unit: mm

Specification inquiry (F34)

※ Contact us with below information.

- Fluid - _____
- Specific gravity - Standard-1.0 Other _____
- Pressure - Standard-6.0kg/cm² Other ___ kg/cm²
- Temperature - Normal temperature Other ___ °C
- Scale Range - _____ L/min ~ _____ L/min
- Adaptor Size - 1" JIS
 Other _____
- Adaptor Material
 - Welding Type Male Thread
 - Female Thread Butt-fusion Adaptor
 - Panel Elbow Thread Other _____
- Inductor - Yes No
- Other - _____

F45Series - 346mm large size pipe size 1-1/2"-2" **F45 series**

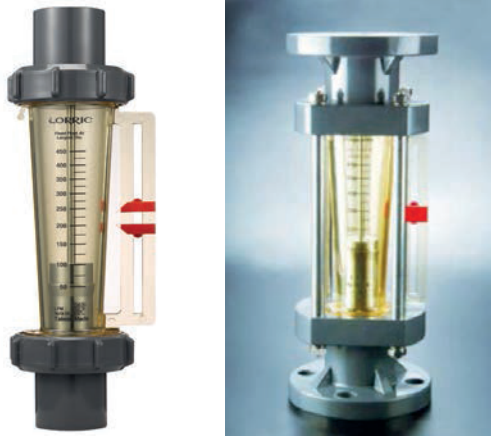

Product Features · Use

- The flange flow meter is equipped with four stainless steel poles on four sides and uses flange adaptor. This flow meter is robust, highly secure and ideal for high pressure conditions. This flow meter's lifetime is usually longer than ordinary flow meters.
- Patented dual-indicator design for easy and clear flow range management.
- Laser engraved degree scales provide better readability and longer life.
- Available in customizable units, temperature, and molecular weight.
- Each batch of flow meters will be calibrated before delivery for our best precision guarantee.
- Hastelloy float is available for corrosive environment.

Standard Specs

- Model: F45PSU, F45H PSU
- Adaptor Size: 1"-1/2", 2"
- Applicable Fluid: Liquid
- Flow direction: From the bottom up
- Engraved degree scales: Laser engraved degree scales
- Fluid Temperature: 50°C (Standard: UPVC adaptor)
- Working Pressure: 6.0 kg/cm²
- Full Scale Accuracy: ±5% F.S.
- Product Material

Body - PSU
 Float - Stainless 316, Hastelloy C
 Guide Rod - Stainless 316, Ti, Hastelloy C
 Guide Rod Bottom - PP
 Adaptor - Welding Type: UPVC
 Male, Female Thread: UPVC, PP
 Butt-fusion Adaptor: PP
 Flange: UPVC
 Union Nuts - UPVC
 O-ring - EPDM, VITON
 Iron pillar (Flange type only) - Stainless 316, 304, 420

- Adaptor Material
- Welding Type, Male Thread, Female Thread,
 Butt-fusion Adaptor, Flange

※ BSPT is standard thread type. NPT is available for custom order.

Scale Range

Product Code	Scale Range※	Standard gravity
F45 (PSU,H PSU) - 100LPM	10-100 L/min	1.0
F45 (PSU,H PSU) - 150LPM	15-150 L/min	1.0
F45 (PSU,H PSU) - 200LPM	20-200 L/min	1.0
F45 (PSU,H PSU) - 250LPM	25-250 L/min	1.0
F45 (PSU,H PSU) - 300LPM	30-300 L/min	1.0
F45 (PSU,H PSU) - 450LPM	50-450 L/min	1.0
F45 (PSU,H PSU) - 600LPM	100-600 L/min	1.0

※ Liquid flow meters are calibrated for 20°C water.
 ※ F45 PC product has ceased production.

Parts Material

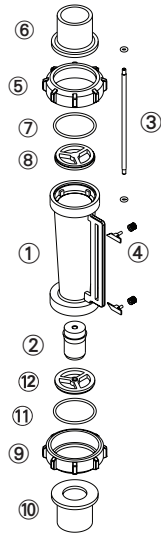

No.	Series	Material (Main material) ^{※ 1}		
		1	2	3
1	Body	PSU	PSU	PSU
2	Float	S316	Hastelloy C	Hastelloy C
3	Guide Rod	S316	Ti	Hastelloy C
4	Pointer	ABS	ABS	ABS
5,9	Union Nuts	UPVC	UPVC	UPVC
6,10	Adaptor	UPVC	UPVC	PSU ^{※ 2}
7,11	O-ring	VITON	VITON	VITON
8,12	Guide Rod Bottom	PP	PP	PP

※ 1. Material for different parts is optional for each flowmeter.

※ 2. For thread adaptor only.

※ 3. F45 PC product has ceased production.

Parts Size

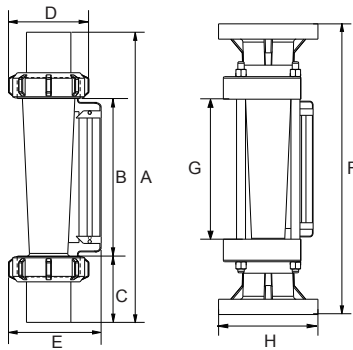

Adaptor Material	A / F [※]	B / G [※]	C / H [※]	D	E
1"-1/2" Male Thread	346	187	79.5	109	127
1"-1/2" JIS	345	187	79	109	127
2" Male Thread	345	187	79	109	127
2" Female Thread	345	187	79	109	127
2" JIS	357	187	85	109	127
PP OD72.7 ID60.2	305	187	59	109	127
PP OD60 ID48.10	345	187	79	109	127
2" Flange	390	187	155 [※]	-	-

※ Size of flange type

Unit: mm

Specification inquiry (F45)

※ Contact us with below information.

- Fluid - Water Other _____
 - Specific gravity - Standard-1.0 Other _____
 - Pressure - Standard-6.0kg/cm² Other ___ kg/cm²
 - Temperature - Normal temperature Other ___ °C
 - Scale Range - _____ L/min ~ _____ L/min
 - Adaptor Size - 1"-1/2" 2"
 Other _____
 - Adaptor Material
 - Welding Type Male Thread
 - Female Thread Butt-fusion Adaptor
 - Panel Elbow Thread Other _____
 - Material
 - 1 Body PSU
 - 2 Body PSU Hastelloy C Float, Ti Guide Rod
 - 3 Body PSU Hastelloy C Float & Guide Rod
 - 4 Other
- Specs besides above listed information _____

F45Magnetic - Magnetic Duel-Indicator pipe size 1-1/2" **F45M**

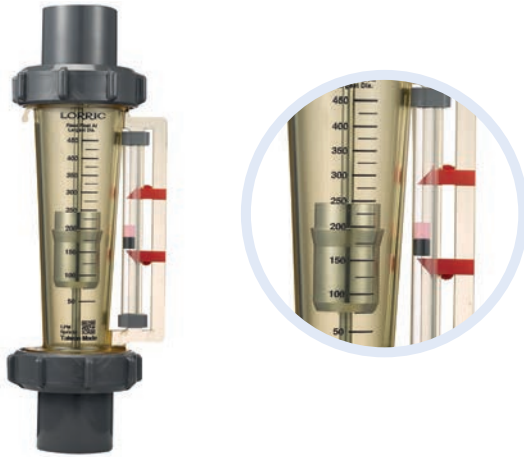

Product Features · Use

- Ideal for dark color and or solutions that easily precipitate.
- Patented dual-indicator design for easy and clear flow range management.
- Laser engraved degree scales provide better readability and longer life.
- Available in customizable units, temperature, and molecular weight.
- Each batch of flow meters will be calibrated before delivery for our best precision guarantee.

Standard Specs

- Model: F45M PSU, F45MH PSU
- Adaptor Size: 1"-1/2", 2"
- Applicable Fluid: Liquid (Dark liquid)
- Flow direction: From the bottom up
- Engraved degree scales: Laser engraved degree scales
- Fluid Temperature: 50°C (Standard)
- Working Pressure: 6.0 kg/cm²
- Full Scale Accuracy: ±5% F.S.
- Product Material

Body - PSU
 Float - Stainless 316, Hastelloy C
 Guide Rod - Stainless 316, Ti, Hastelloy C
 Guide Rod Bottom - PP
 Adaptor - Welding Type: UPVC
 Male, Female Thread: UPVC, PP
 Butt-fusion Adaptor: PP
 Union Nuts - UPVC
 O-ring - EPDM, VITON
 Iron pillar (Flange type only) - Stainless 316, 304, 420

- Adaptor Material
- Welding Type, Male Thread, Female Thread,
 Butt-fusion Adaptor, Flange

※ BSPT is standard thread type. NPT is available for custom order.

Scale Range

Product Code	Scale Range*	Standard gravity
F45M PSU - 300LPM	50-300 L/min	1.0
F45M PSU - 450LPM	50-450 L/min	1.0
F45M PSU - 600LPM	100-600 L/min	1.0

※ Liquid flow meters are calibrated for 20°C water.

Parts Material

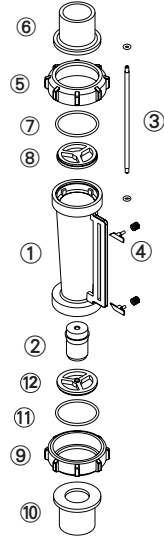

No.	Series	Material (Main material)*			
		1	2	3	4
1	Body	PSU	PSU	PSU	PSU
2	Float	S316	S316	S316	S316
3	Guide Rod	S316	S316	S316	S316
4	Pointer	ABS	ABS	ABS	ABS
5,9	Union Nuts	UPVC	UPVC	UPVC	UPVC
6,10	Adaptor	UPVC	UPVC	Flange UPVC	Male / Female Thread PSU
7,11	O-ring	VITON	EPDM	VITON	VITON
8,12	Guide Rod Bottom	PP	PP	PP	PP

* Material for different parts is optional for each flowmeter.

Parts Size

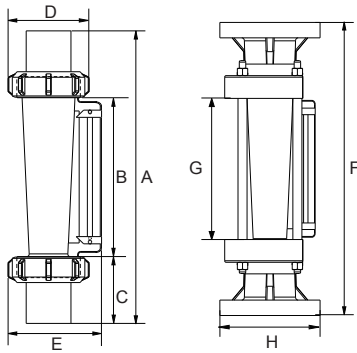

Adaptor Material	A / F*	B / G*	C / H*	D	E
1"-1/2" Female Thread	346	187	79.5	109	127
1"-1/2" JIS	345	187	79	109	127
2" Male Thread	345	187	79	109	127
2"Female Thread	345	187	79	109	127
2" JIS	357	187	85	109	127
PP OD72.7 ID60.2	305	187	59	109	127
PP OD60 ID48.10	345	187	79	109	127
2" Flange	390	187	155	-	-

* Size of flange type

Unit: mm

Specification inquiry (F45M PSU)

* Contact us with below information.

- Fluid - Water Other _____
- Specific gravity - Standard-1.0 Other _____
- Pressure - Standard-6.0kg/cm² Other _____ kg/cm²
- Temperature - Normal temperature Other _____ °C
- Scale Range - _____ L/min ~ _____ L/min
- Adaptor Size - 1"-1/2" 2"
 Other _____

- Adaptor Material
 - Welding Type Male Thread
 - Female Thread Butt-fusion Adaptor
 - Panel Elbow Thread Other _____
- Material
 - 1 UPVC 2 EPDM O-ring
 - 3 UPVC Flange
 - 4 PSU Male / Female Thread
 - 5 Other

Specs besides above listed information _____

F46Series - 346mm large size pipe size 1-1/2"-2" **F46 series**



Product Features · Use

- Designed for use with highly corrosive solutions.
- Patented dual-indicator design for easy and clear flow range management.
- Laser engraved degree scales provide better readability and longer life.
- Available in customizable units, temperature, and molecular weight.
- Each batch of flow meters will be calibrated before delivery for our best precision guarantee.

Standard Specs

- Model: F46PSU
- Adaptor Size: 1"-1/2", 2"
- Applicable Fluid: Liquid (Highly corrosive)
- Flow direction: From the bottom up
- Engraved degree scales: Laser engraved degree scales
- Fluid Temperature: 50°C (Standard)
- Working Pressure: 6.0 kg/cm²
- Full Scale Accuracy: ±5% F.S.
- Product Material

Body - PSU
 Float - PP, Teflon
 Guide Rod - None
 Guide Rod Bottom - PP
 Adaptor - Welding Type: UPVC
 Male, Female Thread: UPVC, PP
 Butt-fusion Adaptor: PP

Union Nuts - UPVC
 O-ring - EPDM, VITON

● Adaptor Material

Welding Type, Male Thread, Female Thread,
 Butt-fusion Adaptor

※ BSPT is standard thread type. NPT is available for custom order.

Scale Range

Product Code	Scale Range*	Standard gravity
F46PSU - 100LPM Teflon float	20-100 L/min	1.0
F46PSU - 150LPM PP float	30-150 L/min	1.0
F46PSU - 200LPM PP float	35-200 L/min	1.0
F46PSU - 300LPM PP float	35-250 L/min	1.0

※ Liquid flow meters are calibrated for 20°C water.

Parts Material

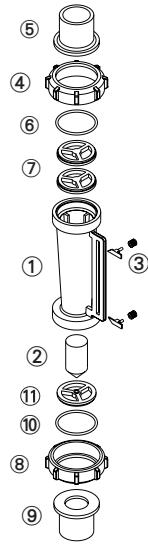

No.	Series	Material (Main material) ^{※ 1}			
		1	2	3	4
1	Body	PSU	PSU	PSU	PSU
2	Float	Teflon	PP	PP	PP
3	Guide Rod	ABS	ABS	ABS	ABS
4,8	Pointer	UPVC	UPVC	UPVC	UPVC
5,9	Adaptor	UPVC	UPVC	UPVC	PSU ^{※ 2}
6,10	O-ring	VITON	EPDM	VITON	VITON
7,11	Guide Rod Bottom	PP	PP	PP	PP

※ 1. Material for different parts is optional for each flowmeter.
 ※ 2. For thread adaptor only.

Parts Size

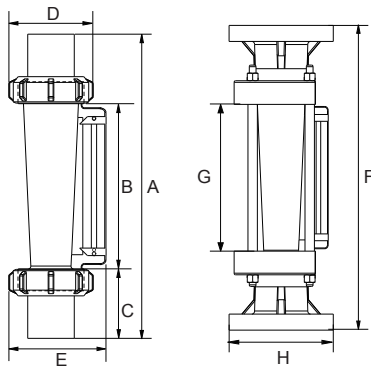

Adaptor Material	A / F [※]	B / G [※]	C / H [※]	D	E
1"-1/2" Female Thread	346	187	79.5	109	127
1"-1/2" JIS	345	187	79	109	127
2" Male Thread	345	187	79	109	127
2" Female Thread	345	187	79	109	127
2" JIS	357	187	85	109	127
PP OD72.7 ID60.2	305	187	59	109	127
PP OD60 ID48.10	345	187	79	109	127
2" Flange	390	187	155	-	-

※ Size of flange type

Unit: mm

Specification inquiry (F46)

※ Contact us with below information.

- Fluid - Water Other _____
 - Specific gravity - Standard-1.0 Other _____
 - Pressure - Standard-6.0kg/cm² Other _____ kg/cm²
 - Temperature - Normal temperature Other _____ °C
 - Scale Range - _____ L/min ~ _____ L/min
 - Adaptor Size - 1"-1/2" 2"
 Other _____
 - Adaptor Material
 - Welding Type Male Thread
 - Female Thread Butt-fusion Adaptor
 - Panel Elbow Thread Other _____
 - Material
 - 1 Teflon float 2 PP float
 - 3 PP float VITON O-ring
 - 4 PP float PSU adaptor
 - 5 Other
- Specs besides above listed information _____

F101- New 168mm middle size pipe size 1/2" F101 series



Product Features · Use

- 4 design innovations to improve usability:
 New body design: Decreases the vibration when working which stabilises flow distribution./ New indicator design: Easily adjustable and positionable./ Thickened threads for caps: Caps are easy to be locked even under bad concentricity./ Models with and without guide rods are able to share the same adaptors.
- Patented dual-indicator design for easy and clear flow range management.
- Laser engraved degree scales provide better readability and longer life.
- Available in customizable units, temperature, and molecular weight.

Standard Specs

- Model: F101PC, F101PSU, F101H PSU
- Adaptor Size: 1/2"
- Applicable Fluid: Liquid
- Flow direction: From the bottom up
- Fluid Temperature: 50°C (Standard: UPVC adaptor)
 60°C (PP adaptor)
 70°C(PVDF adaptor)
- Working Pressure: 5.0 kg/cm² MAX
- Full Scale Accuracy: ±5% F.S.
- Product Material _____
 Body - PC, PSU
 Float - Stainless 316, Hastelloy C
 Guide Rod - Stainless 316, Ti, Hastelloy C
 Guide Rod Bottom - PP, FRPP
 Adaptor - Welding Type: UPVC
 Male, Female Thread: UPVC, PVDF
 Butt-fusion Adaptor: PP
 Union Nuts - UPVC, Aluminum
 O-ring - EPDM, VITON
- Adaptor Material _____
 Welding Type, Male Thread, Female Thread,
 Butt-fusion Adaptor
 ※ BSPT is standard thread type. NPT is available for custom order.

Scale Range

Product Code	Scale Range* 1 ※ 2 (L/min)
F101-2LPM	0.2-2.0 / S, H
F101-5LPM	0.5-5.0 / S, H
F101-10LPM	1.0-10 / S, H
F101-15LPM	1.5-15 / S, H
F101-20LPM	2.0-20 / S, H

※ 1.Liquid flow meters are calibrated for 20°C water.
 ※ 2."/ "float material, S- Stainless 316, H- Hastelloy C.

Maximum working temperature for different adaptor materials

Adaptor Types	Maximum working temperature materials		
	~ 50°C	~ 60°C	~ 70°C
Welding Type	UPVC	-	-
Male / Female Thread	UPVC	-	PVDF
Butt-fusion Adaptor	-	PP	-

※ When maximum working temperature is over 50°C, the material for guide rod bottom and union nuts have to be PSU and aluminium.

Parts Material

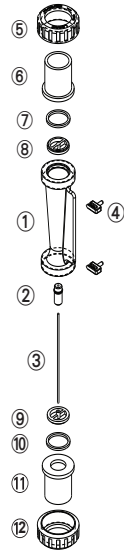

No.	Series	Material (Main material)*			
		1	2	3	4
1	Body	PC	PC	PSU	PSU
2	Float	S316	S316	Hastelloy C	Hastelloy C
3	Guide Rod	S316	S316	Ti	Hastelloy C
4	Pointer	PP	PP	PP	PP
5,12	Union Nuts	UPVC	UPVC	UPVC	Aluminum
6,11	Adaptor	UPVC	UPVC	UPVC	UPVC
7,10	O-ring	EPDM	VITON	VITON	VITON
8,9	Guide Rod Bottom	PP	PP	PP	PP

* Material for different parts is optional for each flowmeter.

Parts Size

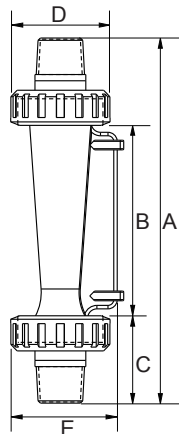

Adaptor Material	A	B	C	D	E
1/2" Male Thread	164	85	39.5	43	49.5
1/2" Female Thread	166	85	40.5	43	49.5
1/2" JIS	166	85	40.5	43	49.5

Unit: mm

Specification inquiry (F101)

* Contact us with below information.

- Fluid - Water Other _____
- Specific gravity - Standard-1.0 Other _____
- Pressure - Standard-5.0kg/cm² Other ___ kg/cm²
- Temperature - Normal temperature Other ___ °C
- Scale Range - _____ L/min ~ _____ L/min
- Adaptor Size - 3/4" JIS Other _____
- Adaptor Material - Welding Type Male Thread
 Female Thread Butt-fusion Adaptor
 Other _____
- Material
 - 1 Body PC 2 Body PSU
 - 3 Body PSU Hastelloy C Float, Ti Guide Rod
 - 4 Body PSU Hastelloy C Float & Guide Rod
Adaptor PSU (for high working temperature)
 - 5 Other
Specs besides above listed information _____

F201- New 192mm middle size pipe size 1/2"-3/4" **F201 series**



Product Features · Use

- 4 design innovations to improve usability:
New body design: Decreases the vibration when working which stabilises flow distribution./ New indicator design: Easily adjustable and positionable./ Thickened threads for caps: Caps are easy to be locked even under bad concentricity./ Models with and without guide rods are able to share the same adaptors.
- Patented dual-indicator design for easy and clear flow range management.
- Laser engraved degree scales provide better readability and longer life.
- Available in customizable units, temperature, and molecular weight.

Standard Specs

- Model: F201PC, F201PSU, F201H PSU
- Adaptor Size: 1/2", 3/4"
- Applicable Fluid: Liquid
- Flow direction: From the bottom up
- Engraved degree scales: Laser engraved degree scales
- Fluid Temperature: 50°C (Standard: UPVC adaptor)
60°C (PP adaptor)

- Working Pressure: 5.0kg/cm²
- Full Scale Accuracy: ±5% F.S.
- Product Material

Body - PC, PSU
 Float - Stainless 316, Hastelloy C
 Guide Rod - Stainless 316, Ti, Hastelloy C
 Guide Rod Bottom - PP
 Adaptor - Welding Type: UPVC
 Male, Female Thread: UPVC, PP
 Butt-fusion Adaptor: PP

Union Nuts - UPVC
 O-ring - EPDM, VITON

- Adaptor Material
- Welding Type, Male Thread, Female Thread,
 Butt-fusion Adaptor

※ BSPT is standard thread type. NPT is available for custom order.

Scale Range

Product Code	Scale Range ※ 1※ 2 (L/min)
F201-10LPM	1.0-10 / S, H
F201-15LPM	1.5-15 / S, H
F201-20LPM	2.0-20 / S, H
F201-30LPM	3.0-30 / S, H
F201-40LPM	4.0-40 / S, H
F201-50LPM	5.0-50 / S, H

※ 1. Liquid flow meters are calibrated for 20°C water.
 ※ 2. / "float material, S- Stainless 316, H- Hastelloy C.

Maximum working temperature for different adaptor materials

Adaptor Types	Maximum working temperature materials		
	~ 50°C	~ 60°C	~ 100°C
Welding Type	UPVC	-	-
Male / Female Thread	UPVC	PP	-
Butt-fusion Adaptor	-	PP	-

※ When maximum working temperature is over 50°C, the material for guide rod bottom and union nuts have to be PSU and aluminium.

Parts Material

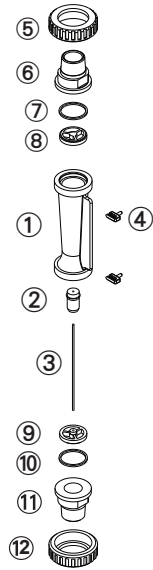

No.	Series	Material (Main material)*			
		1	2	3	4
1	Body	PC	PSU	PSU	PSU
2	Float	S316	S316	Hastelloy C	PVC
3	Guide Rod	S316	S316	Ti	Hastelloy C
4	Pointer	PP	PP	PP	PP
5,12	Union Nuts	UPVC	UPVC	UPVC	UPVC
6,11	Adaptor	UPVC	UPVC	UPVC	UPVC
7,10	O-ring	EPDM	VITON	VITON	VITON
8,9	Guide Rod Bottom	PP	PP	PP	PP

* Material for different parts is optional for each flowmeter.

Parts Size

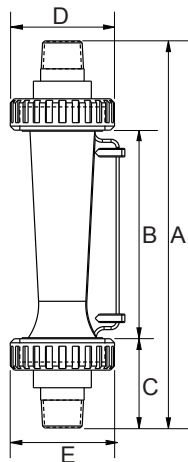

Adaptor Material	A	B	C	D	E
3/4" Male Thread	192	102	45	51	56
3/4" JIS	194	102	46	51	56
1/2" Male Thread	182	102	40	51	56
1/2" Female Thread	192	102	45	51	56
1/2" JIS	184	102	41	51	56

Unit: mm

Specification inquiry (F201)

* Contact us with below information.

- Fluid - Water Other _____
- Specific gravity - Standard-1.0 Other _____
- Pressure - Standard-5.0kg/cm² Other ___ kg/cm²
- Temperature - Normal temperature Other ___ °C
- Scale Range - _____ L/min ~ _____ L/min
- Adaptor Size - 3/4" JIS Other _____
- Adaptor Material - Welding Type Male Thread
 - Female Thread Butt-fusion Adaptor
 - Other _____
- Material
 - 1 Body PC 2 Body PSU
 - 3 Body PSU Hastelloy C FloaT, Ti Guide Rod
 - 4 Body PSU Hastelloy C Float & Guide Rod
- Other
Specs besides above listed information _____

F301- New 270mm large size pipe size 3/4"-1" **F301 series**



Product Features · Use

- 4 design innovations to improve usability:
New body design: Decreases the vibration when working which stabilises flow distribution./ New indicator design: Easily adjustable and positionable./ Thickened threads for caps: Caps are easy to be locked even under bad concentricity./ Models with and without guide rods are able to share the same adaptors.
- Patented dual-indicator design for easy and clear flow range management.
- Laser engraved degree scales provide better readability and longer life.
- Available in customizable units, temperature, and molecular weight.

Standard Specs

- Model: F301PSU, F301H PSU
- Adaptor Size: 1/2", 3/4", 1"
- Applicable Fluid: Liquid
- Flow direction: From the bottom up
- Engraved degree scales: Laser engraved degree scales
- Fluid Temperature: 50°C (Standard: UPVC adaptor)
60°C (PP adaptor)

- Working Pressure: 5.0 kg/cm²
- Full Scale Accuracy: ±5% F.S.
- Product Material

Body - PSU
 Float - Stainless 316, Hastelloy C
 Guide Rod - Stainless 316, Hastelloy C
 Guide Rod Bottom - PP
 Adaptor - Welding Type: UPVC
 Male, Female Thread: UPVC, PP
 Butt-fusion Adaptor: PP

- Adaptor Material
- Union Nuts - UPVC
- O-ring - EPDM, VITON
- Welding Type, Male Thread, Female Thread, Butt-fusion Adaptor

※ BSPT is standard thread type. NPT is available for custom order.

Scale Range

Product Code	Scale Range ※ 1 ※ 2 (L/min)
F301 - 20LPM	2.0-20 / S, H
F301 - 30LPM	3.0-30 / S, H
F301 - 50LPM	5.0-50 / S, H
F301 - 80LPM	8.0-80 / S, H
F301 - 100LPM	10-100 / S, H

※ 1. Liquid flow meters are calibrated for 20°C water.

※ 2. " / " float material, S- Stainless 316, H- Hastelloy C.

Maximum working temperature for different adaptor materials

Adaptor Types	Maximum working temperature materials		
	~ 50°C	~ 60°C	~ 100°C
Welding Type	UPVC	-	-
Male / Female Thread	UPVC	PP	-
Butt-fusion Adaptor	-	PP	-

※ When maximum working temperature is over 50°C, the material for guide rod bottom and union nuts have to be PSU and aluminium.

※ If the maximum working temperature requirement of the adapter is over 60°C, please contact LORRIC directly.

Parts Material

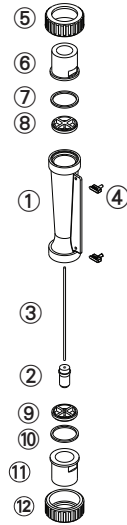

No.	Series	Material (Main material)*			
		1	2	3	4
1	Body	PSU	PSU	PSU	PSU
2	Float	S316	S316	Hastelloy C	PVC
3	Guide Rod	S316	S316	Ti	Hastelloy C
4	Pointer	PP	PP	PP	PP
5,12	Union Nuts	UPVC	UPVC	UPVC	UPVC
6,11	Adaptor	UPVC	UPVC	UPVC	UPVC
7,10	O-ring	EPDM	VITON	VITON	VITON
8,9	Guide Rod Bottom	PP	PP	PP	PP

* Material for different parts is optional for each flowmeter.

Parts Size

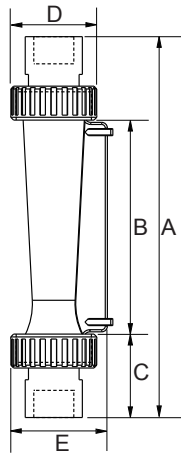

Adaptor Material	A	B	C	D	E
1" Male Thread	270	153	58.5	61	69
1" Female Thread	270	153	58.5	61	69
1" JIS	255	153	51	61	69
PP OD33 ID25.2	254	153	50.5	61	69
3/4" Male Thread	256	153	51.5	61	69
3/4" JIS	260	153	53.5	61	69

Unit: mm

Specification inquiry (F301)

* Contact us with below information.

- Fluid - Water Other _____
- Specific gravity - Standard-1.0 Other _____
- Pressure - Standard-5.0kg/cm² Other ___kg/cm²
- Temperature - Normal temperature Other ___°C
- Scale Range - _____ L/min ~ _____ L/min
- Adaptor Size - 1" JIS Other _____
- Adaptor Material - Welding Type Male Thread
 - Female Thread Butt-fusion Adaptor
 - Other _____
- Material
 - 1 Body PC 2 Body PSU
 - 3 Body PSU Hastelloy C FloaT, Ti Guide Rod
 - 4 Body PSU Hastelloy C Float & Guide Rod Adaptor PSU (for high working temperature)
 - 5 Other
 - Specs besides above listed information _____

F311- New 195mm middle size pipe size 1/2"-1" F311 series



Product Features · Use

- 4 design innovations to improve usability:
New body design: Decreases the vibration when working which stabilises flow distribution./ New indicator design: Easily adjustable and positionable./ Thickened threads for caps: Caps are easy to be locked even under bad concentricity./ Models with and without guide rods are able to share the same adaptors.
- Patented dual-indicator design for easy and clear flow range management.
- Laser engraved degree scales provide better readability and longer life.
- Available in customizable units, temperature, and molecular weight.

Standard Specs

- Model: F311 PSU
- Adaptor Size: 1/2", 3/4", 1"
- Applicable Fluid: Liquid
- Flow direction: From the bottom up
- Engraved degree scales: Laser engraved degree scales
- Fluid Temperature: 50°C (Standard: UPVC adaptor)
60°C (PP adaptor)
- Working Pressure: 5.0 kg/cm²
- Full Scale Accuracy: ±5% F.S.
- Product Material
 - Body - PSU
 - Float - Stainless 316, Hastelloy C
 - Guide Rod - Stainless 316
 - Guide Rod Bottom - PP
 - Adaptor - Welding Type: UPVC
 - Male, Female Thread: UPVC, PP
 - Butt-fusion Adaptor: PP
 - Union Nuts - UPVC
 - O-ring - EPDM, VITON

Adaptor Material

Welding Type, Male Thread, Female Thread, Butt-fusion Adaptor

※ BSPT is standard thread type. NPT is available for custom order.

Scale Range

Product Code	Scale Range※ 1 ※ 2 (L/min)
F311 - 80LPM	23-80 / S, H
F311 - 100LPM	20-100 / S, H

※ 1. Liquid flow meters are calibrated for 20°C water.
 ※ 2. / "float material, S- Stainless 316, H- Hastelloy C.

Maximum working temperature for different adaptor materials

Adaptor Types	Maximum working temperature materials	
	~ 50°C	~ 60°C
Welding Type	UPVC	-
Male / Female Thread	UPVC	PP
Butt-fusion Adaptor	PP	PP

Parts Material

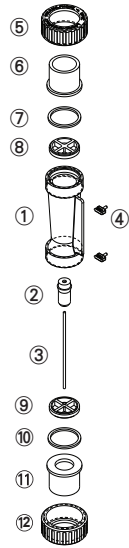

No.	Series	Material (Main material)* 1			
		1	2	3	4
1	Body	PSU	PSU	PSU	PSU
2	Float	S316	S316	S316	S316
3	Guide Rod	S316	S316	S316	S316
4	Pointer	PP	PP	PP	PP
5,12	Union Nuts	UPVC	UPVC	UPVC	UPVC
6,11	Adaptor	UPVC	UPVC	PP**2	PP**2
7,10	O-ring	EPDM	VITON	VITON	VITON
8,9	Guide Rod Bottom	PP	PP	PP	PP

※ 1. Material for different parts is optional for each flowmeter.
 ※ 2. For thread and welding adaptor only.

Parts Size

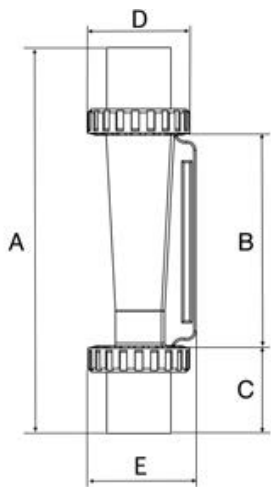

Adaptor Material	A	B	C	D	E
1" Male Thread	211	93	59	61	67
1" Female Thread	210	93	58.5	61	67
1" JIS	196	93	51.5	61	67
3/4" Male Thread	197	93	52	61	67
3/4" Female Thread	212	93	59.5	61	67
3/4" JIS	200	93	53.5	61	67
1/2" JIS	190	93	48.5	61	67
PP OD33 ID25.3	194	93	50.5	61	67

Unit: mm

Specification inquiry (F311)

※ Contact us with below information.

- Fluid - Water Other _____
- Specific gravity - Standard-1.0 Other _____
- Pressure - Standard-5.0kg/cm² Other ___ kg/cm²
- Temperature - Normal temperature Other ___ °C
- Scale Range - _____ L/min ~ _____ L/min
- Adaptor Size - 1" JIS
 Other _____
- Adaptor Material
 Welding Type Male Thread
 Female Thread Butt-fusion Adaptor
 Other _____
- Inductor - Yes No
- Other - _____



FCCE

Product Features · Use

- Pipe installation - No downtime / No pipe cut / No water leakage / No blocking
Maintenance at any time, greatly reducing installation and maintenance costs. No damage, no blockage, no leakage or pressure problems.
- Global power adapter attached to the device can be directly connected to the general power supply, plug and play.
- Easy to install. For two-way flow measurement, no need to consider liquid flow during installation. Patented algorithm technology to enhance anti-interference ability. Waterproof probe.
- Optional mounting rail provided, the probe is placed in range, easy to accurately install with fixed, stable detection results.

Conveniently Attach Probe To Pipe

**No downtime · Avoid cutting pipes
No leaks · No blockages**

Installing our Ultrasonic flowmeter means that maintenance can be done at any time. It dramatically reduces installation and maintenance costs as the pipe can remain as it is. This means no damage to the tube and saves you from causing leakage and pressure problems.



Patented Design All plastic high resistance probe with lattice grid

- All plastic buckles can be glued or welded, which greatly improves probe installation, convenience, and reliability. This solves past issues where the strap installation was easily displaced by temperature and vibration.
- Patented buckle fits close to pipelines, greatly improves the accuracy of traffic detection, with stable detection results.
- The only all-plastic buckle on the market allows probes and buckles to be used for long periods even in the electronics, chemicals, environmental protection, and other chemical-filled environments.

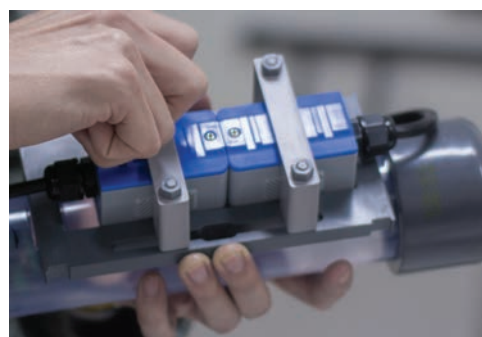

Standard Specs

Installation method	Tube clamps	Power consumption	< 2W
Measurement principle	Time differential	Transient flow	Instantaneous flow, flow velocity, time differential display
Flow rate range	$\pm 0.1 \sim 20$ m / s	Cumulative flow	Positive and negative cumulative, net flow display
Measurement accuracy	< ± 2 %	Units	Metric or English units
Response time	<1 second	Power	9~30VDC 100-240 50 / 60Hz AC transformer
Resolution	0.0001 m/s	Display	128 x 64 LCD backlight display
Wired communication	Analog output 4-20 mA Modbus RS485 Two-line	Security	Keyboard lock, power-loss data protection
Probe-to-host distance	10 m	Operation button	4 touch button
Temperature measurement	Two sets of external PT1000	Shell	ABS plastic, 145 x 90 x 45 mm
Temperature range	-100 ~ 300 ° C with 0.1 ° C resolution	Applicable pipe material	Cast iron, carbon steel, stainless steel, PVC pipe and other
Device working temperature	-25~70°C	Applicable pipe diameter (mm)	50mm~200mm(standard equipment)
Applicable fluid	Clean water, oil or chemical with minor impurities	Probe waterproof rating	General probe IP61 Glue probe IP65 Waterproof resistance probe IP68
Wall temperature	Standard probe: 0~80°C High temperature probe: 0~150°C		

Size

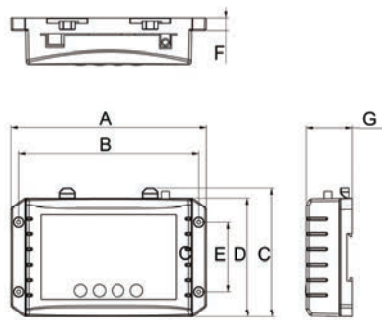

A	B	C	D	E	F	G
149.5	137.8	98.3	90.5	52.4	9.5	34.9

Unit : mm

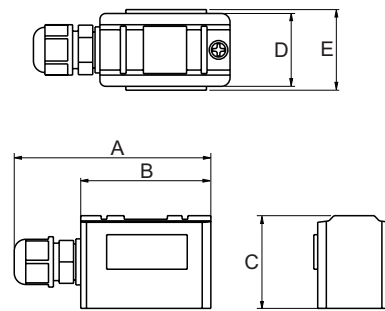

A	B	C	D	E
68.3	45.2	32.2	25.3	42.6

Unit : mm

Compare with other measurement principles on the market

	Variable area	Paddle wheel	Electromagnetic	Non-invasive ultrasound
Pressure drop	Low	Medium	No	No
Non-destructive installation	No	No	No	Yes
Accuracy	Medium	Medium	Highest	Highest
Measure bidirectional flow	No	Yes	Yes	Yes
Blockage potential	Will block	Easy to block	Will not block	Will not block
Measurable fluid	Gas ∙ Liquid	Liquid	Conductive liquid	Liquid (Including organic matter)
Price	Relatively low price for smaller pipes	Low price The price increases with the diameter	High price The price increases with the diameter	Medium price Price does not increase with the diameter

Gas Flowmeter

LORRIC[®]
paranoid about performance

F20A	38
F30A	40
F201A.....	42
F301A.....	44

F20A - 192mm middle size pipe size 1/2"-3/4"

F20A series

This product will stop production by December 31st, 2018.



Product Features · Use

- Patented dual-indicator design for easy and clear flow range management.
- Laser engraved degree scales provide better readability and longer life.
- Available in customizable units, temperature, and molecular weight.
- Each batch of flow meters will be calibrated before delivery for our best precision guarantee.
- Perpendicular joint is available for space saving installation.
- Hastelloy float is available for corrosive environment.

Standard Specs

- Model: F20A, F20AH
- Adaptor Size: 1/2", 3/4"
- Applicable Fluid: Gas
- Flow direction: From the bottom up
- Engraved degree scales: Laser engraved degree scales
- Fluid Temperature: 50°C (Standard: UPVC adaptor)
60°C (PP adaptor)
100°C (PSU adaptor)

- Working Pressure: 6.0kg/cm²
- Full Scale Accuracy: ±5% F.S.

Product Material

Body - PSU
 Float - PVC, Stainless 316, Ti
 Guide Rod - Stainless 316, Hastelloy C
 Guide Rod Bottom - UPVC, PSU
 Adaptor - Welding Type: UPVC
 Male, Female Thread: UPVC, PP, PSU
 Butt-fusion Adaptor: PP
 Panel Elbow Thread: UPVC

Union Nuts - UPVC, Aluminum
 O-ring - EPDM, VITON

Adaptor Material

Welding Type, Male Thread, Female Thread,
 Butt-fusion Adaptor, Panel Elbow Thread

※ BSPT is standard thread type. NPT is available for custom order.

Scale Range

Product Code	Scale Range*
F20A(PVC) PSU - 30NLPM	3.0-30 NL/min
F20A(PVC) PSU - 50NLPM	5.0-50 NL/min
F20A(PVC) PSU - 100NLPM	10-100 NL/min
F20A(S316) PSU - 350NLPM	35-350 NL/min
F20A(S316) PSU - 500NLPM	50-500NL/min
F20A(S316) PSU - 1000NLPM	100-1000 NL/min
F20AH PSU - 350NLPM	35-350NL/min
F20AH PSU - 500NLPM	50-500 NL/min
F20AH PSU - 1000NLPM	100-1000 NL/min

※ Liquid flow meters are calibrated for 20°C water.

Maximum working temperature for different adaptor materials

Adaptor Types	Maximum working temperature materials		
	~ 50°C	~ 60°C	~ 100°C
Welding Type	UPVC	-	-
Male / Female Thread	UPVC	PP	PSU
Butt-fusion Adaptor	PP	PP	-
Panel Elbow Thread	UPVC	-	-

※ When maximum working temperature is over 50°C, the material for guide rod bottom and union nuts have to be PSU and aluminium.

Parts Material

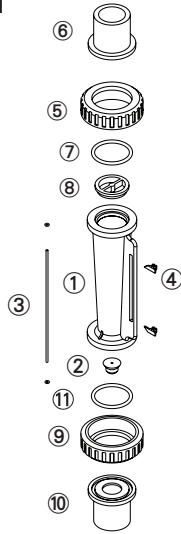

No.	Series	Material (Main material)* 1			
		1	2	3	4
1	Body	PSU	PSU	PSU	PSU
2	Float	PVC	S316	Hastelloy C	Hastelloy C
3	Guide Rod	S316	S316	Ti	Hastelloy C
4	Pointer	ABS	ABS	ABS	ABS
5,9	Union Nuts	UPVC	UPVC	UPVC	Aluminum
6,10	Adaptor	UPVC	UPVC	UPVC	PSU** 2
7,11	O-ring	EPDM	VITON	VITON	VITON
8	Guide Rod Bottom	UPVC	UPVC	PSU	PSU

※ 1. Material for different parts is optional for each flowmeter.
 ※ 2. For thread adaptor only.

Parts Size

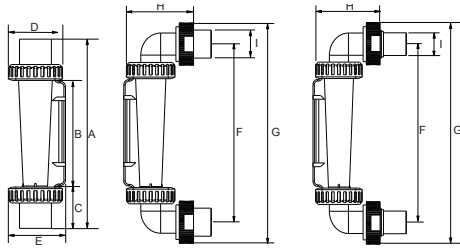

Adaptor Material	A	B	C	D	E	F	G	H	I
3/4" Male Thread	192	104	44	51	56.5	-	-	-	-
3/4" Female Thread	189	104	42.5	51	56.5	-	-	-	-
3/4" JIS	199	104	47.5	51	56.5	-	-	-	-
PP OD32 ID26	181	104	38.5	51	56.5	-	-	-	-
PP OD32.2 ID26.2	192	104	44	51	56.5	-	-	-	-
1/2" Male Thread	192	104	44	51	56.5	-	-	-	-
1/2" Female Thread	184	104	40	51	56.5	-	-	-	-
1/2" JIS	185	104	40.5	51	56.5	-	-	-	-
3/4" Panel Elbow Male Thread	-	104	-	51	56.5	180	219	55	27

Unit: mm

Specification inquiry (F201A)

※ Contact us with below information.

- Fluid - Gas Other _____
- Specific gravity - Standard-1.0 Other _____
- Pressure - Standard-6.0kg/cm² Other ___ kg/cm²
- Temperature - Normal temperature Other ____ °C
- Scale Range - _____ L/min ~ _____ L/min
- Adaptor Size - Standard-3/4" Other _____
- Adaptor Material - Welding Type Male Thread
 - Female Thread Butt-fusion Adaptor
 - Panel Elbow Thread Other _____

- Material
 - 1 Body PC 2 Body PSU
 - 3 Body PSU Hastelloy C Float, Ti Guide Rod
 - 4 Body PSU Hastelloy C Float & Guide Rod Adaptor PSU (for high working temperature)
 - 5 Other
- Specs besides above listed information _____

F30A - 270 mm large size pipe size 3/4"-1" F30A series

This product will stop production by December 31st, 2018.



Product Features · Use

- Patented dual-indicator design for easy and clear flow range management.
- Laser engraved degree scales provide better readability and longer life.
- Available in customizable units, temperature, and molecular weight.
- Each batch of flow meters will be calibrated before delivery for our best precision guarantee.
- Perpendicular joint is available for space saving installation.
- Hastelloy float is available for corrosive environment.

Standard Specs

- Model: F30A PSU, F30AH AIR
- Adaptor Size: 1/2", 3/4"
- Applicable Fluid: Gas
- Flow direction: From the bottom up
- Engraved degree scales: Laser engraved degree scales
- Fluid Temperature: 50°C (Standard: UPVC adaptor)
60°C (PP adaptor)
100°C (PSU adaptor)

- Working Pressure: 6.0kg/cm²
- Full Scale Accuracy: ±5% F.S.
- Product Material

Body - PSU
 Float - PVC, Stainless 316, Ti
 Guide Rod- Stainless 316, Hastelloy C
 Guide Rod Bottom - UPVC, PSU
 Adaptor- Welding Type: UPVC
 Male, Female Thread: UPVC, PP, PSU
 Butt-fusion Adaptor: PP
 Panel Elbow Thread: UPVC

Union Nuts - UPVC, Aluminum
 O-ring - EPDM, VITON

- Adaptor Material
- Welding Type, Male Thread, Female Thread,
 Butt-fusion Adaptor, Panel Elbow Thread

※ BSPT is standard thread type. NPT is available for custom order.

Scale Range

Product Code	Scale Range*
F30A(PVC) PSU - 400NLPM	40-400 NL/min
F30A(PVC) PSU - 500NLPM	50-500 NL/min
F30A(PVC) PSU - 700NLPM	70-700 NL/min
F30A(S316) PSU - 1000NLPM	100-1000 NL/min
F30A(H) PSU - 1000NLPM	100-1000 NL/min

※ Liquid flow meters are calibrated for 20°C water.

Maximum working temperature for different adaptor materials

Adaptor Types	Maximum working temperature materials		
	~ 50°C	~ 60°C	~ 100°C
Welding Type	UPVC	-	-
Male / Female Thread	UPVC	PP	PSU
Butt-fusion Adaptor	PP	PP	-
Panel Elbow Thread	UPVC	-	-

※ When maximum working temperature is over 50°C, the material for union nuts/ guide rod bottom and O-ring have to be PSU and VITON.

Parts Material

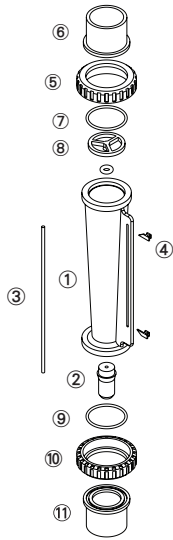

No.	Series	Material (Main material)* 1			
		1	2	3	4
1	Body	PSU	PSU	PSU	PSU
2	Float	PVC	S316	Hastelloy C	Hastelloy C
3	Guide Rod	S316	S316	Ti	Hastelloy C
4	Pointer	ABS	ABS	ABS	ABS
5,10	Union Nuts	UPVC	UPVC	UPVC	Aluminum
6,11	Adaptor	UPVC	UPVC	UPVC	PSU* 2
7,9	O-ring	EPDM	VITON	VITON	VITON
8	Guide Rod Bottom	UPVC	UPVC	UPVC	PSU

※ 1. Material for different parts is optional for each flowmeter.
 ※ 2. For thread adaptor only.

Parts Size

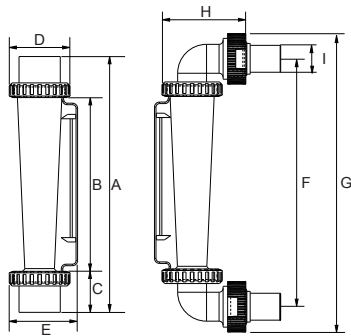

Adaptor Material	A	B	C	D	E
1" Male Thread	272	171	50.5	60	67.5
1" Female Thread	272	171	50.5	60	67.5
1" JIS	253	171	41	60	67.5
PP OD33 ID25.2	254	171	41.5	60	67.5
3/4" Male Thread	257	171	43	60	67.5
3/4" JIS	256	171	42.5	60	67.5
1" Panel Elbow Male Thread	-	171	-	60	67.5

Unit: mm

Specification inquiry (F301A)

※ Contact us with below information.

- Fluid - Gas Other _____
- Specific gravity - Standard-1.0 Other _____
- Pressure - Standard-6.0kg/cm² Other ___ kg/cm²
- Temperature - Normal temperature Other ____ °C
- Scale Range - _____ L/min ~ _____ L/min
- Adaptor Size - Standard-1" 3/4"
 Other _____
- Adaptor Material
 - Welding Type Male Thread
 - Female Thread Butt-fusion Adaptor
 - Panel Elbow Thread Other _____
- Material
 - 1 Body PC 2 Body PSU
 - 3 Body PSU Hastelloy C Float, Ti Guide Rod
 - 4 Body PSU Hastelloy C Float & Guide Rod Adaptor PSU (for high working temperature)
 - 5 Other
Specs besides above listed information _____

F201A- New 192mm middle size pipe size 1/2"-3/4" F201A series



Product Features · Use

- 4 design innovations to improve usability:
New body design: Decreases the vibration when working which stabilises flow distribution./ New indicator design: Easily adjustable and positionable./ Thickened threads for caps: Caps are easy to be locked even under bad concentricity./ Models with and without guide rods are able to share the same adaptors.
- Patented dual-indicator design for easy and clear flow range management.
- Laser engraved degree scales provide better readability and longer life.
- Available in customizable units, temperature, and molecular weight.

Standard Specs

- Model: F201APC, F201APSU, F201AH PSU
- Adaptor Size: 1/2", 3/4"
- Applicable Fluid: Gas
- Flow direction: From the bottom up
- Engraved degree scales: Laser engraved degree scales
- Fluid Temperature: 50°C (Standard: UPVC adaptor)
60°C (PP adaptor)

- Working Pressure: 5.0kg/cm²
- Full Scale Accuracy: ±5% F.S.
- Product Material

Body - PC, PSU
 Float - Stainless 316, Hastelloy C
 Guide Rod - Stainless 316, Ti, Hastelloy C
 Guide Rod Bottom - PP
 Adaptor - Welding Type: UPVC
 Male, Female Thread: UPVC, PP
 Butt-fusion Adaptor: PP

- Union Nuts - UPVC
 - O-ring - EPDM, VITON
 - Adaptor Material
- Welding Type, Male Thread, Female Thread,
 Butt-fusion Adaptor

※ BSPT is standard thread type. NPT is available for custom order.

Scale Range

Product Code	Scale Range ※ 1※ 2 (NLPM)
F201A-30NLPM	3.0-30 / P
F201A-50NLPM	5.0-50 / P
F201A-100NLPM	10-100 / P
F201A-350NLPM	35-350 / S, H
F201A-500NLPM	50-500 / S, H
F201A-1000NLPM	100-1000 / S, H

※ 1. Gas flow meters are calibrated for normal condition. (0°C, 1 atm)
 ※ 2. " / "float material, S- Stainless 316, P- PVC, H- Hastelloy C.

Maximum working temperature for different adaptor materials

Adaptor Types	Maximum working temperature materials		
	~ 50°C	~ 60°C	~ 100°C
Welding Type	UPVC	-	-
Male / Female Thread	UPVC	PP	-
Butt-fusion Adaptor	-	PP	-

※ When maximum working temperature is over 50°C, the material for guide rod bottom and union nuts have to be PSU and aluminium.
 ※ If the maximum working temperature requirement of the adaptor is over 60°C, please contact LORRIC directly.

Parts Material

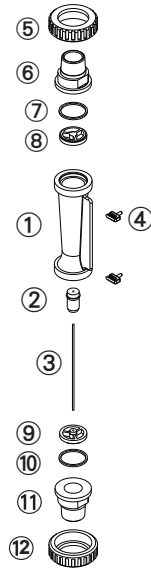

No.	Series	Material (Main material)*			
		1	2	3	4
1	Body	PC	PSU	PSU	PSU
2	Float	S316	S316	Hastelloy C	PVC
3	Guide Rod	S316	S316	Ti	Hastelloy C
4	Pointer	PP	PP	PP	PP
5,12	Union Nuts	UPVC	UPVC	UPVC	UPVC
6,11	Adaptor	UPVC	UPVC	UPVC	UPVC
7,10	O-ring	EPDM	VITON	VITON	VITON
8,9	Guide Rod Bottom	PP	PP	PP	PP

* Material for different parts is optional for each flowmeter.

Parts Size

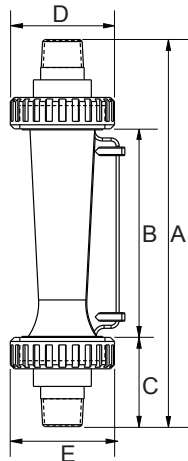

Adaptor Material	A	B	C	D	E
3/4" Male Thread	192	102	45	51	56
3/4" JIS	194	102	46	51	56
1/2" Male Thread	182	102	40	51	56
1/2" Female Thread	192	102	45	51	56
1/2" JIS	184	102	41	51	56

Unit: mm

Specification inquiry (F201A)

* Contact us with below information.

- Fluid - Gas Other _____
- Specific gravity - Standard-1.0 Other _____
- Pressure - Standard-5.0kg/cm² Other ___ kg/cm²
- Temperature - Normal temperature Other ___ °C
- Scale Range - _____ L/min ~ _____ L/min
- Adaptor Size - 3/4" JIS Other _____
- Adaptor Material - Welding Type Male Thread
 Female Thread Butt-fusion Adaptor
 Other _____
- Material
 1 Body PC 2 Body PSU
 3 Body PSU Hastelloy C FloaT, Ti Guide Rod
 4 Body PSU Hastelloy C Float & Guide Rod
- Other
 Specs besides above listed information _____

F301A- New 270mm large size pipe size 3/4"-1" **F301A series**



Product Features · Use

- 4 design innovations to improve usability:
New body design: Decreases the vibration when working which stabilises flow distribution./ New indicator design: Easily adjustable and positionable./ Thickened threads for caps: Caps are easy to be locked even under bad concentricity./ Models with and without guide rods are able to share the same adaptors.
- Patented dual-indicator design for easy and clear flow range management.
- Laser engraved degree scales provide better readability and longer life.
- Available in customizable units, temperature, and molecular weight.

Standard Specs

- Model: F301A PSU, F301AH PSU
- Adaptor Size: 1/2", 3/4", 1"
- Applicable Fluid: Gas
- Flow direction: From the bottom up
- Engraved degree scales: Laser engraved degree scales
- Fluid Temperature: 50°C (Standard: UPVC adaptor)
60°C (PP adaptor)

- Working Pressure: 5.0 kg/cm²
- Full Scale Accuracy: ±5% F.S.
- Product Material

Body - PSU
 Float - Stainless 316, Hastelloy C
 Guide Rod - Stainless 316, Hastelloy C
 Guide Rod Bottom - PP
 Adaptor - Welding Type: UPVC
 Male, Female Thread: UPVC, PP
 Butt-fusion Adaptor: PP
 Union Nuts - UPVC
 O-ring - EPDM, VITON

- Adaptor Material
- Welding Type, Male Thread, Female Thread,
 Butt-fusion Adaptor

※ BSPT is standard thread type. NPT is available for custom order.

Scale Range

Product Code	Scale Range ※ 1 ※ 2 (NLPM)
F301A - 400NLPM	40-400 / P
F301A - 500NLPM	50-500 / P
F301A - 700NLPM	70-700 / P
F301A - 1000NLPM	100-1000 / S, H

※ 1. Gas flow meters are calibrated for normal condition. (0°C , 1 atm)
 ※ 2. " / "float material, S- Stainless 316, P- PVC, H- Hastelloy C.

Maximum working temperature for different adaptor materials

Adaptor Types	Maximum working temperature materials		
	~ 50°C	~ 60°C	~ 100°C
Welding Type	UPVC	-	-
Male / Female Thread	UPVC	PP	-
Butt-fusion Adaptor	-	PP	-

※ When maximum working temperature is over 50°C, the material for guide rod bottom and union nuts have to be PSU and aluminium.
 ※ If the maximum working temperature requirement of the adapter is over 60°C, please contact LORRIC directly.

Parts Material

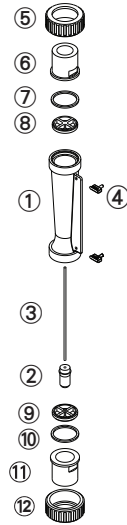

No.	Series	Material (Main material)*			
		1	2	3	4
1	Body	PSU	PSU	PSU	PSU
2	Float	S316	S316	Hastelloy C	PVC
3	Guide Rod	S316	S316	Ti	Hastelloy C
4	Pointer	PP	PP	PP	PP
5,12	Union Nuts	UPVC	UPVC	UPVC	UPVC
6,11	Adaptor	UPVC	UPVC	UPVC	UPVC
7,10	O-ring	EPDM	VITON	VITON	VITON
8,9	Guide Rod Bottom	PP	PP	PP	PP

* Material for different parts is optional for each flowmeter.

Parts Size

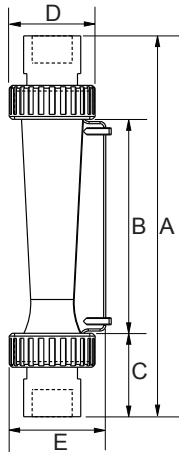

Adaptor Material	A	B	C	D	E
1" Male Thread	270	153	58.5	61	69
1" Female Thread	270	153	58.5	61	69
1" JIS	255	153	51	61	69
PP OD33 ID25.2	254	153	50.5	61	69
3/4" Male Thread	256	153	51.5	61	69
3/4" JIS	260	153	53.5	61	69

Unit: mm

Specification inquiry (F301A)

* Contact us with below information.

- Fluid - Gas Other _____
- Specific gravity - Standard-1.0 Other _____
- Pressure - Standard-5.0kg/cm² Other ___ kg/cm²
- Temperature - Normal temperature Other ___ °C
- Scale Range - _____ L/min ~ _____ L/min
- Adaptor Size - 1" JIS Other _____
- Adaptor Material - Welding Type Male Thread
 Female Thread Butt-fusion Adaptor
 Other _____

- Material
 - 1 Body PC 2 Body PSU
 - 3 Body PSU Hastelloy C FloaT, Ti Guide Rod
 - 4 Body PSU Hastelloy C Float & Guide Rod
Adaptor PSU (for high working temperature)
 - 5 Other
Specs besides above listed information _____



LORRIC
United Benefit Corp.

8F, No.3, Lane 83, Sec. 1, Guangfu Rd.,
Sanhong Dist. New Taipei City
TEL : +886-2-8511-2135
FAX : +886-2-8511-2097
E-mail : sales@lorric.com
www.lorric.com

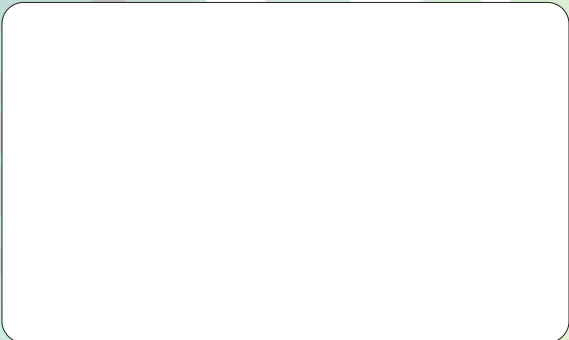

LORRIC Nozzle Product Catalogue 2018. September

